



PRODUCT CATALOGUE
(VOL.5)
w.e.f 01st Jan. 2024

The Propeller Shaft People



RAGHUNATH UDYOG

(ISO 9001:2008 Certified)



ABOUT US

Started in 1962 , and based in New Delhi, Raghunath Udyog and it's brand RDS Compo is an ISO 9001: 2008 certified company which develops, manufactures and market, cutting edge automotive components. The company now in it's 61st year is a pioneer in the manufacturing of Propeller Shafts and it's components. Our strength through the years has been uncompromising levels of high quality standards that we are able to maintain because of our thorough research and development processes and our complete in-house production facility where we pay the closest of detail to each and every process.

RDS Compo prides itself on having the largest range of U J Crosses, Propeller Shaft Components, Steering & Suspension range & Centre Bearing Assemblies in India.

Backed by world class technology and driven by a dedicated team of dynamic professionals, we believe in procuring only the best tested alloy variants to manufacture international standard products. Our emphasis on research and development is immense. We are constantly pushing the envelope towards manufacturing and technical excellence.

At RDS Compo, we make systems our priority, and we believe in doing things right. From start to finish we work on the theories of precision, efficiency and accuracy. Keeping in line with this theory we have made significant investments in building our infrastructure and have acquired state of the art machinery and developed newer in-house methods of production.

With this continuous growth, we have expanded our export network beyond Indian shores. We are currently supplying to many countries in Africa and have regular business from Sri Lanka , Bangladesh and Nepal. But its the national customer that is our priority. Our godowns and indeed our warehouses are always stocked to the brim thereby ensuring that delivery does not suffer. We are blessed with a convenient location in the heart of the national capital region of Delhi, easily accessible for all our clients. In addition we have a large distribution network which helps facilitate the quick distribution of goods and products to all our customers.

At RDS Compo, we believe that the amalgamation of quality and quantity can go hand in hand if the simple things are done properly. We are committed to providing the precision product we are renowned for, to help drive a new generation forward.



U.J. Crosses



Flange Yoke Cross Holders



Stub Half Yokes



Coupling Flanges



Long Fork Yokes
(With Dust Cover)



Slip Bottle / Rear Housings



Long Fork & Bottle Set



Welch Plugs
(Half Yoke & Rear Housing Assy.)



Front Teeths



Yoke & Teeth
(LCVs Division)



Yoke & Teeth
(HCVs Division)



Clutch Forks



Propeller Shaft Components
(Tata 1210, 1312, 407, Tata ACE, Magic, L/L 370, L/Taskar, L/Cargo, Ambassador, Mahindra & Mahindra, Eicher & Swaraj Mazda)



Steering Spindles
(Yoke & Teeth)



Gear Cross Assemblies
(Jhamela)



Steering Cross Assemblies



Centre Bearing Assemblies



Centre Bearing Assemblies
(With Heavy Duty Bracket)



Engine Mountings



Rubber Hollow Pads / Load Cushions



Torque / V-Rod Bushes



Lift Axle Bushes



Misc. Rubber Components



TATA SIGNA 3118, 3718, 4323, 4923

| Part No. | Description | Housing Thread | Ball Pin Thread | Spanner Size  | LIST PRICE |
|----------|--|----------------|-----------------|--|---------------|
| RDS 1222 | Tie Rod End (Right Thread) (Sealing Type) Tata 3718 Signa, LPT 3118 (BS III) (with Thick Taper Ball Pin - 29.4 mm) | M30 x 1.5 | M24 x 1.5 | 36 mm | Rs.1,120 Each |
| RDS 1223 | Tie Rod End (Left Thread) (Sealing Type) Tata 3718 Signa, LPT 3118 (BS III) (with Thick Taper Ball Pin - 29.4 mm) | M30 x 1.5 | M24 x 1.5 | 36 mm | Rs.1,120 Each |
| RDS 1224 | Tie Rod End (Right Thread) (Sealing Type) Tata 3718 Signa, LPT 3118 (BS III) Second Rod (with Thin Taper Ball Pin - 27.3 mm) | M30 x 1.5 | M24 x 1.5 | 36 mm | Rs.1,120 Each |
| RDS 1225 | Tie Rod End (Left Thread) (Sealing Type) Tata 3718 Signa, LPT 3118 (BS III) Second Rod (with Thin Taper Ball Pin - 27.3 mm) | M30 x 1.5 | M24 x 1.5 | 36 mm | Rs.1,120 Each |
| RDS 1228 | Tie Rod End (Right Thread) (PLUG TYPE) Tata 3718 Signa, LPT 3118 (BS III) (with Thick Taper Ball Pin - 29.4 mm) | M30 x 1.5 | M24 x 1.5 | 36 mm | Rs.1,340 Each |
| RDS 1229 | Tie Rod End (Left Thread) (PLUG TYPE) Tata 3718 Signa, LPT 3118 (BS III) (with Thick Taper Ball Pin - 29.4 mm) | M30 x 1.5 | M24 x 1.5 | 36 mm | Rs.1,340 Each |
| RDS 1230 | Tie Rod End (Right Thread) (PLUG TYPE) Tata 3718 Signa, LPT 3118 (BS III) Second Rod (with Thin Taper Ball Pin - 27.3 mm) | M30 x 1.5 | M24 x 1.5 | 36 mm | Rs.1,340 Each |
| RDS 1231 | Tie Rod End (Left Thread) (PLUG TYPE) Tata 3718 Signa, LPT 3118 (BS III) Second Rod (with Thin Taper Ball Pin - 27.3 mm) | M30 x 1.5 | M24 x 1.5 | 36 mm | Rs.1,340 Each |
| RDS 1641 | Drag Link Assembly Tata 3718 BS III / BS IV, (14 Wheeler) LPK 2523 TC, Signa 3718/4323, Signa 3118 TC, LPK 3118 Tipper (Pipe Length 27.5") (Pipe OD 50 mm) OE Part No. 501346300101/501346900101 DL01191FRT , (For reference only) (2434) | M30 X 1.5 | M20 X 1.5 | 30 mm | Rs. 4,240 |
| RDS 1644 | Drag Link Assembly Tata 4923 Signa (BS III, BS IV), LPK 2518 HD, Tata LPT 2518 COWL (BS IV) (Pipe Length 25.5") (Pipe OD 50 mm) OE Part No. 284646900101/102/103 (For reference only) (2418) | M40 X 1.5 | M24 X 1.5 | 36 mm | Rs. 4,780 |
| RDS 1648 | Drag Link Assembly Tata 3718 (BS VI), Signa 2818, TC COWL (BS VI), Signa 3118 TC, Signa 3718, Signa 4323, LPK 3118 Tipper (Pipe Length 27.5") (Pipe OD 50 mm) (Fitted with RDS 1224, Right Thread) OE Part No. 503046900101 (For reference only) (2470) | M30 X 1.5 | M24 X 1.5 | 36 mm | Rs. 4,400 |
| RDS 1661 | Drag Link Assembly Tata Signa 1918K (BS VI), Signa 4018 (BS VI) Tata Signa 2823HD (BS VI), Signa 4625 (BS VI) (Pipe Length 25") (Pipe OD 50 mm) (Fitted with RDS 1175 Right Thread) OE Part No. 506946900101 (For reference only) (2453) | M40 X 1.5 | M24 X 1.25 | 36 mm | Rs. 4,780 |

TATA LPT 2518, LPT 3118 LONG BODY

| Part No. | Description | Housing Thread | Ball Pin Thread | Spanner Size  | LIST PRICE |
|----------|--|----------------|-----------------|--|---------------|
| RDS 1214 | Tie Rod End set (LH + RH) Tata LPT 2518 (BS III), LPT 3118 (BS III) Cabin / COWL LONG BODY (Fitted with 107 mm Long Ball Pin) | M30x 1.5 | M20 x 1.5 | 30 mm | Rs.2,240 Set |
| RDS 1215 | Tie Rod End (Right Thread) Tata LPT 2518 (BS III), LPT 3118 (BS III) Cabin / COWL LONG BODY (Fitted with 107 mm Long Ball Pin) | M30x 1.5 | M20 x 1.5 | 30 mm | Rs.1,120 Each |
| RDS 1216 | Tie Rod End (Left Thread) Tata LPT 2518 (BS III), LPT 3118 (BS III) Cabin / COWL LONG BODY (Fitted with 107 mm Long Ball Pin) | M30x 1.5 | M20 x 1.5 | 30 mm | Rs.1,120 Each |
| RDS 1660 | Drag Link Assembly Tata LPT 2518 (BS III), Cabin / COWL LPT 3118 (BS III) (Pipe Length 46" , OD 60 mm) OE Ref. No. 284946000113 | M30x 1.5 | M20 x 1.5 | 30 mm | Rs.6,680 Each |

TATA PRIMA / LPT 2518, LPT 3118, LPT 3718

| | | | | | |
|----------|--|-----------|-----------|-------|---------------|
| RDS 1209 | Tie Rod End (Right Thread) Tata Prima, LPT 2518 (BS III) (BEND TYPE) | M38 x 1.5 | M24 x 1.5 | 36 mm | Rs.2,030 Each |
| RDS 1210 | Tie Rod End (Left Thread) Tata Prima, LPT 2518 (BS III) (BEND TYPE) | M38 x 1.5 | M24 x 1.5 | 36 mm | Rs.2,030 Each |
| RDS 1645 | Drag Link Assembly Tata Prima 2528 K, LPK 2518 TC, LPT 3723 TC, 3128 K TC (BS VI), Prima 3530 LX (BS VI) SINGLE BEND (Pipe Length 34") (Pipe OD 50 mm) OE Part No. 288046300102/500946300101 (For reference only) (2403) | M30 X 1.5 | M20 X 1.5 | 30 mm | Rs.4,780 Each |
| RDS 1646 | Drag Link Assembly Tata Prima 2528 K, LPK 2518 TC, LPT 3723 TC, 3128 K TC (BS VI), Prima 3530 LX (BS VI) DOUBLE BEND (Pipe Length 35") (Pipe OD 50 mm) | M30 X 1.5 | M20 X 1.5 | 30 mm | Rs.4,780 Each |
| RDS 1955 | Tie Rod Assembly Tata Prima 2528 K, Lx 2528, 2528 K (Pipe Length 64", OD 50 mm) (Fitted with RDS 1222 + 1223) O.E. Part No. 502133800101 , For Ref. Only (2405) | M30 x 1.5 | M24 x 1.5 | 36 mm | - |
| RDS 1956 | Tie Rod Assembly Tata Prima LPT 2518, LPT 3118, LPT 3718 (Pipe Length 59", OD 45 mm) (Fitted with RDS 1209 + 1210) O.E. Part No. 502133800101 , For Ref. Only (2405) | M38 x 1.5 | M24 x 1.5 | 36 mm | - |
| RDS 1180 | Hydraulic Cylinder End / Ball Joint Tata Prima 3128 (Inner Thread) | M26 x 1.5 | M20 x 1.5 | 30 mm | Rs.1,370 Each |

TATA 2515 Ex / 4018

| Part No. | Description | Housing Thread | Ball Pin Thread | Spanner Size  | LIST PRICE |
|----------|---|----------------|-----------------|--|---------------|
| RDS 1201 | Tie Rod End set (LH + RH) Tata 2515 Ex (Plug Type) | M30 x 1.5 | M18 x 1.5 | 27 mm | Rs.1,970 Set |
| RDS 1202 | Drag Link End (Right Thread) Tata 2515 Ex (Plug Type) | M30 x 1.5 | M18 x 1.5 | 27 mm | Rs.960 Each |
| RDS 1203 | Tie Rod End (Left Thread) Tata 2515 Ex (Plug Type) | M30 x 1.5 | M18 x 1.5 | 27 mm | Rs.960 Each |
| RDS 1666 | Drag Link Assembly Tata 1616, 2416, 2516, 2515 Ex (Pipe Length 28") (Pipe OD 50 mm) (Fitted with RDS 1202 Right Thread) (422) | M30X 1.5 | M18 X 1.5 | 27 mm | Rs. 4,160 |
| RDS 1206 | Tie Rod End set (LH + RH) (PLUG TYPE) Tata 4018 / Leyland IVECO 909 / Eicher Jumbo | M30 x 1.5 | M20 x 1.5 | 30 mm | Rs.1,900 Set |
| RDS 1207 | Tie Rod End (Right Thread) (PLUG TYPE) Tata 4018 / Leyland IVECO 909 / Eicher Jumbo | M30 x 1.5 | M20 x 1.5 | 30 mm | Rs.1,000 Each |
| RDS 1208 | Tie Rod End (Left Thread) (PLUG TYPE) Tata 4018 / Leyland IVECO 909 / Eicher Jumbo | M30 x 1.5 | M20 x 1.5 | 30 mm | Rs.1,000 Each |
| RDS 1235 | Tie Rod End set (LH + RH) (SEALING TYPE) Tata 4018 / Leyland IVECO 909 / Eicher Jumbo | M30 x 1.5 | M20 x 1.5 | 30 mm | Rs.1,760 Set |
| RDS 1236 | Tie Rod End (Right Thread) (SEALING TYPE) Tata 4018 / Leyland IVECO 909 / Eicher Jumbo | M30 x 1.5 | M20 x 1.5 | 30 mm | Rs.900 Each |
| RDS 1237 | Tie Rod End (Left Thread) (SEALING TYPE) Tata 4018 / Leyland IVECO 909 / Eicher Jumbo | M30 x 1.5 | M20 x 1.5 | 30 mm | Rs.900 Each |

TATA ULTRA 1412 BS IV

| | | | | | |
|----------|--|-----------|-----------|-------|----------------|
| RDS 1076 | Tie Rod End set (LH + RH) Tata Ultra 1412 BS IV | M30 x 1.5 | M18 x 1.5 | 27 mm | Rs. 1,395 Set |
| RDS 1077 | Drag Link End Tata Ultra Bus | M30 x 1.5 | M14 x 1.5 | 22 mm | Rs. 730 Each |
| RDS 1664 | Drag Link Assembly Tata ULTRA 1412 (BS IV) (Pipe Length 33") (Pipe OD 50 mm) OE Part No. 552946900104 (For reference only) (2446) | M30 X 1.5 | M18 X 1.5 | 27 mm | Rs. 4,890 Each |

TATA 1210/1312/1613

| Part No. | Description | Housing Thread | Ball Pin Thread | Spanner Size  | LIST PRICE |
|-------------|--|----------------|-----------------|--|---------------|
| RDS 1951 | Tie Rod Assembly Tata 1210, 1510, 1516, 1612, 2213, (Pipe Length 62") (Pipe OD 38 mm) (Fitted with RDS 1000) | M24 x 1.5 | M18 x 1.5 | 27 mm | Rs.3,600 Each |
| RDS 1000 | Tie Rod End set Tata 1210 / 1312 / 1613 (LH + RH) | M24 x 1.5 | M18 x 1.5 | 27 mm | Rs.1,250 Set |
| RDS 1000 R | Tie Rod End Tata 1210 / 1312 / 1613 (Right Thread) | M24 x 1.5 | M18 x 1.5 | 27 mm | Rs.715 Each |
| RDS 1000 L | Tie Rod End Tata 1210 / 1312 / 1613 (Left Thread) | M24 x 1.5 | M18 x 1.5 | 27 mm | Rs.715 Each |
| RDS 1001 | Tie Rod Repair Kit Tata 1210 / 1312 / 1613 (2 Ball Pins Head 30 mm) (Material Used EN 18) | - | M18 X 1.5 | 27 mm | Rs.490 Kit |
| RDS 1002 | Drag Link Repair Kit Tata 1210 (1 Ball Pin 30 mm Head & 1 Ball Pin 35 mm Head) | - | M18 X 1.25 | 27 mm | Rs.570 Kit |
| RDS 1003 | Drag Link Repair Kit Tata 1616 / 2416 Turbo (2 Ball Pins with 35 mm Head) | - | M18 X 1.25 | 27 mm | Rs.580 Kit |
| RDS 1004 | Gear Lever End Tata 1510 / 1612 (2 pcs. Right Thread) (Greaseless) | M18 x 1.5 | M12 x 1.5 | 19 mm | Rs.610 Set |
| RDS 1005 | Gear Lever End Tata 1510 / 1612 (2 pcs. Left Thread) (Greaseless) | M18 x 1.5 | M12 x 1.5 | 19 mm | Rs.610 Set |
| RDS 1006 GL | Gear Lever End Tata 1510 (Long Thread) (2 pcs. Right thread) (Greaseless) | M18 x 1.5 | M12 x 1.5 | 19 mm | Rs.610 Set |

TATA ULTRA 1518 BS III, BS IV

| | | | | | |
|----------|--|-----------|-----------|-------|---------------------|
| RDS 1175 | Drag Link End Tata Ultra 1518 BS III, BS IV Tata Signa 4923 TC, 4923 LPT, LPK 2518 TC | M40 x 1.5 | M24 x 1.5 | 36 mm | Rs. 1,370 Each |
| RDS 1667 | Drag Link Assembly Tata ULTRA 1518 (BS III, BS IV) (Pipe Length 31.5") (Pipe OD 50 mm) (Fitted with RDS 1175) OE Part No. 553046600109 (For reference only) (2419) | M40X 1.5 | M24 X 1.5 | 36 mm | Rs. 5,050 Each - |

TATA 407 / 407 TURBO / 407 PICK UP

| Part No. | Description | Housing Thread | Ball Pin Thread | Spanner Size  | LIST PRICE |
|----------|---|----------------|-----------------|--|---------------|
| RDS 1952 | Tie Rod Assembly Tata 407 (LP / SFC Model) (Pipe Length 50") (Pipe OD 32 mm) (Fitted with RDS 1011) (O.E. Part No. 265133800106, For Ref. Only) (426) | M18 x 1.5 | M12 x 1.5 | 19 mm | Rs.2,520 Each |
| RDS 1014 | Drag Link Assembly Tata 407 (SFC Model) STRAIGHT (Both Side Adjustable) (Pipe Length 15.5", OD 28 mm) (Fitted with RDS 1011) | M18 x 1.5 | M12 x 1.5 | 19 mm | Rs.1,395 Each |
| RDS 1017 | Drag Link Assembly Tata 407 Turbo LP (Bend Type) (Pipe Length 33", OD 35 mm) (Fitted with RDS 1012 Right Thread) | M20 x 1.5 | M12 x 1.5 | 19 mm | - |
| RDS 1012 | Tie Rod End Tata 407 Turbo | M20 x 1.5 | M12 x 1.5 | 19 mm | Rs.890 Set |
| RDS 1013 | Tie Rod Repair Kit Tata 407 | - | M12 x 1.5 | 19 mm | - |
| RDS 1016 | Tie Rod End Tata 410 / 407 Pick Up | M24 x 1.5 | M12 x 1.5 | 19 mm | Rs.920 Set |

TATA 608

| | | | | | |
|----------|--|-----------|-----------|-------|------------|
| RDS 1021 | Tie Rod End set Tata 608 (LH + RH) | M20x 1.5 | M14 x 1.5 | 22mm | Rs.870 Set |
| RDS 1022 | Tie Rod End set (Right Thread) Tata 608 (2 Pcs Right Thread) | M20 x 1.5 | M14 x 1.5 | 22 mm | Rs.870 Set |
| RDS 1023 | Tie Rod Repair Kit Tata 608 | - | M14 x 1.5 | 22 mm | - |
| RDS 1955 | Tie Rod Assembly Tata 608 (LP / SFC Model) (Pipe Length 51.5") (Pipe OD 32 mm) (Fitted with RDS 1021) | M20 x 1.5 | M14 x 1.5 | 22 mm | - |
| RDS 1024 | Drag Link Assembly Tata 608 SFC (STRAIGHT) (Both Side Adjustable) (Pipe Length 13.5") (Pipe OD 32 mm) (Fitted with RDS 1021) | M20 x 1.5 | M14 x 1.5 | 22 mm | - |

TATA 609, 709 / 709 TURBO

| Part No. | Description | Housing Thread | Ball Pin Thread | Spanner Size  | LIST PRICE |
|----------|--|----------------|-----------------|--|---------------|
| RDS 1953 | Tie Rod Assembly Tata 609 (LP / SFC Model) (Pipe Length 51.5" , OD 35mm) (Fitted with RDS 1031) | M20 X 1.5 | M16 x 1.5 | 24 mm | Rs.2,700 Each |
| RDS 1650 | Drag Link Assembly Tata 609 / 709 Truck (SFC Model) (Pipe Length 14.5" , OD 32 mm) (Both sides Adjustable) | M20 X 1.5 | M14 x 1.5 | 22 mm | Rs.1,440 Each |
| RDS 1651 | Drag Link Assembly Tata 609 / 709 LPT (Pipe Length 33.5" , OD 32 mm) (Both sides Adjustable) | - | - | - | - |
| RDS 1031 | Tie Rod End set Tata 609 / 709 (LH + RH) | M20 x 1.5 | M16 x 1.5 | 24 mm | Rs.850 Set |
| RDS 1032 | Tie Rod End set Tata 709 Turbo (LH + RH) | M22 x 1.5 | M16 x 1.5 | 24 mm | Rs.930 Set |
| RDS 1033 | Tie Rod Repair Kit Tata 709 | - | M16 x 1.5 | 24 mm | - |
| RDS 1034 | Gear Lever End Tata 709 (Inner Thread) (2 Pcs Right Thread) | M12 X 1.25 | M10 x 1.25 | 17 mm | Rs.425 Set |
| RDS 1035 | Gear Lever End Tata 709 (Inner Thread) (2 Pcs Left Thread) | M12 X 1.25 | M10 x 1.25 | 17 mm | Rs.425 Set |
| RDS 1036 | Drag Link Kit Tata 609, 709 SFC (FULL) (1 Pcs. D/L End + Kit) | M20 X 1.5 | M14 x 1.5 | 22 mm | Rs.690 Kit |
| RDS 1038 | Gear Lever End Tata 709 (Inner Thread) (1 Pc. Left Thread + 1 Pc Right Thread) | M12 X 1.25 | M10 x 1.25 | 17 mm | Rs.425 Set |
| RDS 1040 | Drag Link Kit Tata 709 (Rane Type) (1 Pc Ball Pin & Accessories) | - | M14 x 1.5 | 22 mm | Rs.320 Each |

TATA 909 / 1109 EX / 712

| Part No. | Description | Housing Thread | Ball Pin Thread | Spanner Size  | LIST PRICE |
|----------|--|----------------|-----------------|--|------------|
| RDS 1221 | Tie Rod End set Tata 909 / 1109 EX / 712 N/M (LH + RH) | M24x 1.5 | M16 x 1.5 | 24mm | Rs.960 Set |

TATA ACE / MAGIC

| | | | | | |
|----------|---|------------|------------|-------|-------------|
| RDS 1081 | Tie Rod End set Tata ACE (छोटा हाथी), Maruti Van / OMNI (LH + RH) | M14 x 1.5 | M12 x 1.25 | 17 mm | Rs.500 Set |
| RDS 1083 | Drag Link Assembly Tata ACE (छोटा हाथी), (Both Sides Adjustable) (Fitted with RDS 1081) (Pipe Line 25.5", OD 22 mm) | M14 x 1.5 | M12 x 1.25 | 17 mm | Rs.920 Each |
| RDS 1034 | Gear Lever End Tata 709 / Tata ACE (Inner Thread) (2 Pcs Right Thread) | M12 X 1.25 | M10 x 1.25 | 17 mm | Rs.425 Set |
| RDS 1101 | Tie Rod End set Tata Magic (LH + RH) | M14 X 1.5 | M12 x 1.25 | 17 mm | Rs.560 Set |
| | | | | | |

ACE MEGA / TATA INTRA / TATA IRIS / ZIP

| | | | | | |
|----------|--|------------|------------|-------|---------------|
| RDS 1102 | Tie Rod End set Tata IRIS / ZIP (LH + RH) | M12 X 1.25 | M12 x 1.25 | 17 mm | Rs.500 Set |
| RDS 1103 | Tie Rod End set Ace MEGA / Super Ace MINT Dicor Engine (LH + RH) OE Ref. No. 552333990101 / 102 | M18 X 1.5 | M12 x 1.5 | 19 mm | Rs.680 Set |
| RDS 1652 | Drag Link Assembly Ace MEGA (Dicor Engine) (Both Side Adjustable) (Fitted with RDS 1103) (Pipe Length 25.5", OD 28 mm) | M18 X 1.5 | M12 x 1.5 | 19 mm | Rs.1,460 Each |
| RDS 1104 | Tie Rod End set Tata INTRA V 10 / Ace GOLD / Mahindra SUPRO (LH + RH) OE Ref. No. 554533800106 / 107 | M16 X 1.5 | M12 x 1.25 | 19 mm | Rs.530 Set |
| RDS 1653 | Drag Link Assembly Tata INTRA / Ace GOLD (Both Side Adjustable) (Fitted with RDS 1104) (Pipe Length 21", OD 25 mm) | M16 X 1.5 | M12 x 1.25 | 17 mm | Rs.1,100 Each |

Many more to come

BHARAT BENZ 3123, 2523 C

| Part No. | Description | Housing Thread | Ball Pin Thread | Spanner Size  | LIST PRICE |
|----------|---|----------------|-----------------|--|----------------|
| RDS 1212 | Tie Rod End set (LH + RH) Bharat Benz 1617 R (Long Rod) | M30 X 1.5 | M24 x 1.5 | 36 mm | Rs. 3,180 Set |
| RDS 1213 | Tie Rod End set (LH + RH) Bharat Benz 3123, 2523 C (Short Rod) | M30 X 1.5 | M24 x 1.5 | 36 mm | Rs. 2,240 Set |
| RDS 1663 | Drag Link Assembly Bharat Benz 3123 Tipper (Pipe Length 31.5") (Pipe OD 40 mm) (Fitted with RDS 1224 Right Thread) OE Part No. A4004600605 (For reference only) (2618) | M30 X 1.5 | M24 X 1.5 | 41 mm | Rs. 4,400 Each |
| RDS 1647 | Drag Link Assembly Bhart Benz 1617 (Heavy Duty) (Double Bend) (Fitted with RDS 1213 Right Thread) (Pipe Length 33.8") (Pipe OD 40 mm) OE Part No. A4004601205 (For reference only) (2614) | M30 X 1.5 | M24 X 1.5 | 41 mm | Rs. 4,400 Each |
| - | Tie Rod Assembly Bhart Benz 3123, 2523 (Fitted with RDS 1213) (Pipe Length 61") (Pipe OD 40 mm) | M30 X 1.5 | M24 X 1.5 | 41 mm | - |
| - | Tie Rod Assembly Bhart Benz 1617 R (Fitted with RDS 1212) (Pipe Length 56.88") (Pipe OD 40 mm) | M30 X 1.5 | M24 X 1.5 | 36 mm | - |
| - | Gear Shifter End Bharat Benz (Outer Thread) O.E. Part No. A4002680289 For Ref. Only | M14 X 1.5 | M10 X 1.25 | 17 mm | - |
| - | Gear Shifter End (LH + RH) Bharat Benz (Inner Thread) | M12 X 1.5 | M10 X 1.25 | 17 mm | - |

MAHINDRA NAVISTAR

| | | | | | |
|----------|--|-----------|-----------|-------|----------------|
| RDS 1226 | Tie Rod End (Left Thread) Mahindra Navistar MN 25 Tipper, MN 31, MN 40 | M30 X 1.5 | M24 x 1.5 | 36 mm | Rs. 1,120 Each |
| RDS 1227 | Tie Rod End (Right Thread) Mahindra Navistar MN 25 Tipper, MN 31, MN 40 | M30 X 1.5 | M24 x 1.5 | 36 mm | Rs. 1,120 Each |
| RDS 1662 | Drag Link Assembly Mahindra NAVISTAR MN 25 Tipper, MN 31, MN 40 (Pipe Length 31") (Pipe OD 50 mm) (Fitted with RDS 1227 Right Thread) (1072) | M30 X 1.5 | M24 X 1.5 | 36 mm | Rs. 4,780 |
| - | Tie Rod Assembly Mahindra NAVISTAR (Pipe Length 62") (Pipe OD 40 mm) (Fitted with RDS 1226 + RDS 1227) (1073) | M30 X 1.5 | M24 X 1.5 | 36 mm | Rs. 4,780 |

LEYLAND IVECO 909

| Part No. | Description | Housing Thread | Ball Pin Thread | Spanner Size  | LIST PRICE |
|-------------------------------|---|----------------|-----------------|--|---------------|
| RDS 1655 | Drag Link Assembly Leyland IVECO 909 (Pipe Length 38" , OD 50 mm) (Fitted with RDS 1207 Right Thread) | M30 X 1.5 | M20 x 1.5 | 30 mm | - |
| RDS 1206 | Tie Rod End set (LH + RH) (PLUG TYPE) Tata 4018 / Leyland IVECO 909 / Eicher Jumbo | M30 x 1.5 | M20 x 1.5 | 30 mm | Rs.1,900 Set |
| RDS 1207 | Tie Rod End (Right Thread) (PLUG TYPE) Tata 4018 / Leyland IVECO 909 / Eicher Jumbo | M30 x 1.5 | M20 x 1.5 | 30 mm | Rs.1,000 Each |
| RDS 1208 | Tie Rod End (Left Thread) (PLUG TYPE) Tata 4018 / Leyland IVECO 909 / Eicher Jumbo | M30 x 1.5 | M20 x 1.5 | 30 mm | Rs.1,000 Each |
| RDS 1235 | Tie Rod End set (LH + RH) (SEALING TYPE) Tata 4018 / Leyland IVECO 909 / Eicher Jumbo | M30 x 1.5 | M20 x 1.5 | 30 mm | Rs.1,760 Set |
| RDS 1236 | Tie Rod End (Right Thread) (SEALING TYPE) Tata 4018 / Leyland IVECO 909 / Eicher Jumbo | M30 x 1.5 | M20 x 1.5 | 30 mm | Rs.900 Each |
| RDS 1237 | Tie Rod End (Left Thread) (SEALING TYPE) Tata 4018 / Leyland IVECO 909 / Eicher Jumbo | M30 x 1.5 | M20 x 1.5 | 30 mm | Rs.900 Each |
| RDS 1172 | Tie Rod / Drag Link Repair Kit Leyland IVECO 909 (FA - 90 Front Axle) | - | M20 x 1.5 | 30 mm | Rs.640 Kit |
| LEYLAND 2516, 3516 N/M | | | | | |
| RDS 1171 | Tie Rod Repair Kit L/L 2516, 3516 N/M | - | M18 x 1.5 | 27mm | Rs. 680 Kit |
| RDS 1205 | Tie Rod End set (LH + RH) L/L 2516, 3516 N/M | M24 x 1.5 | M18 x 1.5 | 27 mm | Rs.1,900 Set |

*Many more
to come*

LEYLAND U TRUCK / LEYLAND 3116

| Part No. | Description | Housing Thread | Ball Pin Thread | Spanner Size  | LIST PRICE |
|----------|---|----------------|-----------------|--|---------------|
| RDS 1954 | Tie Rod Assembly Leyland U Truck (Pipe Length 62") (Pipe OD 50 mm) (Fitted with RDS 1232) (O E Part No. FOM00500, For Ref. Only) (1067) | M30 X 1.5 | M20 x 1.5 | 30 mm | Rs.6,500 Each |
| RDS 1654 | Drag Link Assembly Leyland U TRUCK 4923 TT, 4023 TT, 3518 TT (Pipe Length 32.5" , OD 60 mm) | M30 X 1.5 | M20 x 1.5 | 30 mm | Rs.5,570 Each |
| RDS 1232 | Tie Rod End set (LH + RH) Leyland U TRUCK 4923 TT, 4023 TT, 3518 TT O E Part No. 2665239 / 2665139 (For Ref. Only) | M30 X 1.5 | M20 x 1.5 | 30 mm | Rs.1,960 Set |
| RDS 1233 | Tie Rod End (Right Thread) Leyland U TRUCK 4923 TT, 4023 TT, 3518 TT | M30 x 1.5 | M20 x 1.5 | 30 mm | Rs.1,000 Each |
| RDS 1234 | Tie Rod End (Left Thread) Leyland U TRUCK 4923 TT, 4023 TT, 3518 TT | M30 x 1.5 | M20 x 1.5 | 30 mm | Rs.1,000 Each |
| RDS 1235 | Tie Rod End set (LH + RH) (SEALING TYPE) Tata 4018 / Leyland IVECO 909 / Eicher Jumbo | M30 x 1.5 | M20 x 1.5 | 30 mm | Rs.1,760 Set |
| RDS 1236 | Tie Rod End (Right Thread) (SEALING TYPE) Tata 4018 / Leyland IVECO 909 / Eicher Jumbo | M30 x 1.5 | M20 x 1.5 | 30 mm | Rs.900 Each |
| RDS 1237 | Tie Rod End (Left Thread) (SEALING TYPE) Tata 4018 / Leyland IVECO 909 / Eicher Jumbo | M30 x 1.5 | M20 x 1.5 | 30 mm | Rs.900 Each |
| RDS 1172 | Tie Rod / Drag Link Repair Kit Leyland IVECO 909 (FA - 90 Front Axle) | - | M20 x 1.5 | 30 mm | Rs.640 Kit |
| RDS 1173 | Hydraulic Cylinder End Eicher / Leyland 3116 (Inner Thread) | M30 X 1.5 | M20 x 1.5 | 30 mm | Rs.1,370 Each |

*Many more
to come*

EICHER CANTER 10.50, 10.59, 10.60, 10.60 G, 10.70, 10.80, 10.90, 10.95 / SWARAJ MAZDA

| Part No. | Description | Housing Thread | Ball Pin Thread | Spanner Size  | LIST PRICE |
|----------|---|----------------|-----------------|--|---------------|
| RDS 1051 | Tie Rod End set Eicher Canter (LH + RH) (10.50, 10.59, 10.60, 10.60 G, 10.70, 10.80, 10.90, 10.95) | M20x 1.5 | M14 x 1.5 | 22mm | Rs.1,280 Set |
| RDS 1052 | Tie Rod Repair Kit (10.50, 10.59, 10.60, 10.60 G, 10.70, 10.80, 10.90, 10.95) | - | M14 x 1.5 | 22 mm | Rs.515 Kit |
| RDS 1063 | Gear Shifter Ends (Right Thread) (10.50, 10.59, 10.60, 10.60 G, 10.70, 10.80, 10.90, 10.95) | M10 X 1.25 | M8 x 1.25 | 13 mm | Rs.286 Set |
| RDS 1656 | Drag Link Assembly Eicher Canter (Rane Type) (10.50, 10.59, 10.60, 10.60 G, 10.70, 10.80, 10.90, 10.95) (Pipe Length 25.5", OD 32 mm) | M20 x 1.5 | M14 x 1.5 | 22 mm | Rs.2,620 Each |

EICHER CANTER 11.10 / 10.80 PRO / 60.25 PRO

| | | | | | |
|----------|---|-----------|------------|-------|---------------|
| RDS 1061 | Tie Rod End set Eicher Canter 11.10 (LH + RH) | M20x 1.5 | M18 x 1.5 | 27mm | Rs.1,230 Set |
| RDS 1657 | Drag Link Assembly Eicher Canter 11.10 (Pipe Length 28", Pipe OD 36 mm) (Fitted with RDS 1000 R) | M24 x 1.5 | M18 x 1.5 | 27 mm | Rs.2,920 Each |
| RDS 1001 | Tie Rod Repair Kit Eicher Canter 11.10 / Tata 1210 (2 Ball Pins Head 30 mm) (Material Used EN 18) | - | M18 X 1.5 | 27 mm | Rs.490 Kit |
| RDS 1062 | Tie Rod End Eicher 10.80 PRO (LH + RH) | M24 x 1.5 | M14 X 1.5 | 22 mm | 1,230 Set |
| RDS 1065 | Gear Shifter Ends (Right Thread) Eicher PRO | M10 X 1.5 | M10 x 1.25 | 13 mm | Rs.365 Set |
| RDS 1665 | Drag Link Assembly Eicher PRO 60.25 (Pipe Length 32", OD 50 mm) (Fitted with RDS 1207) O E Ref. No. IA307786 | M30 X 1.5 | M20 x 1.25 | 30 mm | Rs.4,630 Each |
| RDS 1207 | Drag Link End Eicher PRO 60.25 / Tata 4018 | M30 X 1.5 | M20 x 1.25 | 30 mm | Rs.1,000 Each |

EICHER JUMBO 20.16, 33.25, 30.25, 30.25 FE, TERRA 16, TERRA 16 XP, TERRA 16 HD, GALAXY 30.25

| Part No. | Description | Housing Thread | Ball Pin Thread | Spanner Size  | LIST PRICE |
|----------|--|----------------|-----------------|--|----------------|
| RDS 1206 | Tie Rod End set (LH + RH) Eicher JUMBO 20.16, 33.25, 30.25, 30.25 FE, TERRA 16, TERRA 16 XP, TERRA 16 HD, GALAXY 30.25 | M30x 1.5 | M20 x 1.5 | 30mm | Rs.1,900 Set |
| RDS 1207 | Tie Rod End (Right Thread) Eicher JUMBO 20.16, 33.25, 30.25, 30.25 FE, TERRA 16, TERRA 16 XP, TERRA 16 HD, GALAXY 30.25 | M30x 1.5 | M20 x 1.5 | 30mm | Rs.1,000 Each |
| RDS 1208 | Tie Rod End (Left Thread) Eicher JUMBO 20.16, 33.25, 30.25, 30.25 FE, TERRA 16, TERRA 16 XP, TERRA 16 HD, GALAXY 30.25 | M30x 1.5 | M20 x 1.5 | 30mm | Rs.1,000 Each |
| RDS 1172 | Tie Rod / Drag Link Kit Eicher JUMBO 20.16, 33.25, 30.25, 30.25 FE, TERRA 16, TERRA 16 XP, TERRA 16 HD, GALAXY 30.25 | - | M20 x 1.5 | 30 mm | Rs.640 Kit |
| RDS 1658 | Drag Link Assembly Eicher Jumbo 20.25 FE, 30.25 XP, 33.25 20.15 / 5340 WBLP Cabin Model, 35.31 (Pipe Length 33.5") (Pipe OD 45 mm) (Fitted with RDS 1207 Right Thread) OE Part No. IA 203430 (For reference only) | M30X 1.5 | M20 X 1.5 | 30 mm | Rs. 4,630 Each |
| RDS 1659 | Drag Link Assembly Eicher Jumbo 20.16, 20.15, 33.25, 30.25, 30.25 FE, 30.25 XD, TERRA 16, TERRA 16 XP TERRA 16 HD, Galaxy 30.25 (Cabin/ COWL Model) (Pipe Length 50") (Pipe OD 50 mm) OE Ref. No. 114163020, IA208448 | M30X 1.5 | M20 X 1.5 | 30 mm | Rs. 5,720 Each |
| RDS 1064 | Gear Shifter Ends (Right Thread) Eicher Jumbo 20.16, 20.15, 30.25 FE,, 33.25,. TERRA 16, Galaxy 30.25, Cabin COWL Model | M10 X 1.25 | M10 x 1.25 | 13 mm | Rs.350 Set |
| RDS 1173 | Hydraulic Cylinder End Eicher / Leyland 3116 (Inner Thread) | M30 X 1.5 | M20 x 1.5 | 30 mm | Rs.1,370 Each |

SWARAJ MAZDA

| | | | | | |
|----------|---|-----------|-----------|-------|---|
| RDS 1066 | Tie Rod End set Swaraj Mazda (LH + RH) | M18 X 1.5 | M16 x 1.5 | 24 mm | - |
| RDS 1067 | Tie Rod End set Swaraj Mazda N/M (LH + RH) | - | - | - | - |
| RDS 1068 | Drag Link Assembly Swaraj Mazda N/M | - | - | - | - |

MAHINDRA BOLERO

| Part No. | Description | Housing Thread | Ball Pin Thread | Spanner Size  | LIST PRICE |
|----------|--|----------------|-----------------|--|-------------|
| RDS 1121 | Ball Joint Mahindra Bolero (Lower) | - | M14 x 1.5 | 22 mm | - |
| RDS 1122 | Ball Joint Mahindra Bolero (Upper) | - | M16 x 1.5 | 24 mm | - |
| RDS 1123 | Stabilizer Link Assy. Mahindra Bolero | M10 X 1.25 | M12 X 1.25 | 19 mm | - |
| RDS 1124 | Tie Rod End set (LH + RH) Mahindra Bolero | M18 X 1.5 | M12 X 1.5 | 19 mm | Rs. 700 Set |
| RDS 1125 | Tie Rod End set Mahindra Bolero Sports (Power Steering) Inner Thread (RH + RH) | M14 x 1.5 | M12 x 1.5 | 19 mm | - |

TATA SUMO/SPACIO/VICTA/207 DI

| | | | | | |
|----------|---|-----------|-----------|-------|-------------|
| RDS 1041 | Tie Rod End set (LH + RH) Tata Sumo, Mobile, Sierra, Estate | M16 X 1.5 | M12 x 1.5 | 19 mm | Rs. 590 Set |
| RDS 1042 | Ball Joint Tata Sumo (Lower) | - | M18 x 1.5 | 27 mm | - |
| RDS 1043 | Ball Joint Tata Sumo (Upper) | - | M16 x 1.5 | 24 mm | - |
| RDS 1044 | Centre Link Assembly Tata Sumo, Sierra (Both Side Adjustable) (Pipe Length 20", OD 27 mm) | M16 x 1.5 | M12 x 1.5 | 19 mm | - |
| RDS 1045 | Tie Rod End set (LH + RH) Sumo VICTA | M16 x 1.5 | M12 x 1.5 | 19 mm | - |
| RDS 1046 | Tie Rod End set Tata 207 DI Rx THICK THREAD (Bend Type) | M20 x 1.5 | M12 x 1.5 | 19 mm | 1,390 Set |
| RDS 1047 | Tie Rod End set Tata 207 DI Rx THIN THREAD (Bend Type) | M18 x 1.5 | M12 x 1.5 | 19 mm | 1,390 Set |
| RDS 1048 | Centre Link Assembly Victa N/M (Pipe Length 22") O.E. Part No. 282346600123 , For Ref. Only | M14 x 1.5 | - | 22 mm | - |

MAHINDRA MARSHALL / ARMADA

| Part No. | Description | Housing Thread | Ball Pin Thread | Spanner Size  | LIST PRICE |
|----------|---|-----------------------------|-----------------|--|---------------|
| RDS 1091 | Tie Rod End Kit Marshall / Armada (Set of 4 pcs.) | M18 X 1.5 | M12 x 1.5 | 19 mm | Rs. 1,650 Set |
| RDS 1092 | Ball Joint Mahindra Marshall (Lower) | - | M18 x 1.5 | 27 mm | - |
| RDS 1093 | Ball Joint Mahindra Marshall (Upper) | - | M18 x 1.5 | 27 mm | - |
| RDS 1094 | Tie Rod End Kit Max Pick Up / Turbo (Set of 4 Pcs.) | M18 x 1.5 & M20 x 1.5 | M12 x 1.5 | 19 mm | Rs.1,490 Set |
| RDS 1095 | Tie Rod End Jeep O/M (TS 140/TS 64) (Set of 4 Pcs.). | - | - | - | Rs.960 Set |

*Many more
to come*

| Part No. | Description | Housing Thread | Ball Pin Thread | Spanner Size  | LIST PRICE |
|----------|---|----------------|-----------------|--|------------|
| RDS 1641 | Tata 3718 BS III / BS IV, (14 Wheeler) LPK 2523 TC, Signa 3718/4323, Signa 3118 TC , LPK 3118 Tipper (Pipe Length 27.5") (Pipe OD 50 mm) OE Part No. 501346300101/501346900101 DL01191FRT , (For reference only) (2434) | M30 X 1.5 | M20 X 1.5 | 30 mm | Rs. 4,240 |
| RDS 1642 | Tata 1109 Ex (BS IV), LPT 1412 CRx, LPT 1212 CRx (with Sealing Type Ends) (Pipe Length 30.5") (Pipe OD 42 mm) OE Part No.215346600104 (For reference only) (665) | M30 X 1.5 | M18 X 1.5 | 27 mm | Rs. 3,980 |
| RDS 1643 | Tata Prima 2515 TILT, LPK 1613 (BS II) (Power Stg.) LPT 2515, LPT 2518, 3118 C, LPK 1618 C (BS II) (Pipe Length 32.5") (Pipe OD 50 mm) OE Part No. 278246600101 (For reference only) (676) | M30 X 1.5 | M18 X 1.5 | 27 mm | Rs. 4,140 |
| RDS 1644 | Tata 4923 Signa (BS III, BS IV), LPK 2518 HD, Tata LPT 2518 COWL (BS IV) (Pipe Length 25.5") (Pipe OD 50 mm) OE Part No. 284646900101/102/103 (For reference only) (2418) | M40 X 1.5 | M24 X 1.5 | 36 mm | Rs. 4,780 |
| RDS 1645 | Tata Prima 2528 K, LPK 2518 TC, LPT 3723 TC, 3128 K TC (BS VI), Prima 3530 LX (BS VI) SINGLE BEND (Pipe Length 34") (Pipe OD 50 mm) OE Part No. 288046300102/500946300101 (For reference only) (2403) | M30 X 1.5 | M20 X 1.5 | 30 mm | Rs. 4,780 |
| RDS 1646 | Tata Prima 2528 K, LPK 2518 TC, LPT 3723 TC, 3128 K TC (BS VI), Prima 3530 LX (BS VI) DOUBLE BEND (Pipe Length 35") (Pipe OD 50 mm) | M30 X 1.5 | M20 X 1.5 | 30 mm | Rs. 4,780 |
| RDS 1647 | Bhart Benz 1617 (Heavy Duty) (Double Bend) (Fitted with RDS 1213 Right Thread) (Pipe Length 33.8") (Pipe OD 40 mm) OE Part No. A4004601205 (For reference only) (2614) | M30 X 1.5 | M24 X 1.5 | 41 mm | Rs. 4,400 |
| RDS 1648 | Tata 3718 (BS VI), Signa 2818, TC COWL (BS VI), Signa 3118 TC, Signa 3718, Signa 4323, LPK 3118 Tipper (Pipe Length 27.5") (Pipe OD 50 mm) (Fitted with RDS 1224, Right Thread) OE Part No. 503046900101 (For reference only) (2470) | M30 X 1.5 | M24 X 1.5 | 36 mm | Rs. 4,400 |



| Part No. | Description | Housing Thread | Ball Pin Thread | Spanner Size  | LIST PRICE |
|----------|--|----------------|-----------------|--|------------|
| RDS 1649 | Tata LPT 709 EX Turbo (BS II), LP 709 BS-II, LP 909 EX, LP 909 CNG BS-III, LP 712, Star Bus 407 LP CNG (Pipe Length 33", OD 40 mm) (Fitted with RDS 1036) OE Part No. 264146600160/165/158 (For reference only) (672) | M20 X 1.5 | M14 X 1.5 | 22 mm | Rs. 3,140 |
| RDS 1650 | Tata 609/709 Truck (SFC Model) (Pipe Length 14.5") (Pipe Length OD 32 mm) (Both Side Adjustable) (Fitted with RDS 1021) (437) | M20 X 1.5 | M14 X 1.5 | 22 mm | Rs. 1,440 |
| RDS 1651 | Tata 609/709 LPT (Both Side Adjustable) (Fitted with RDS 1021) (Pipe Length 33.5") (Pipe OD 32 mm) | - | - | - | - |
| RDS 1083 | Tata ACE (Mini Truck) छोटा हाथी (Both Side Adjustable) (Fitted with RDS 1081) (Pipe Length 25.5") (Pipe OD 22 mm) | M14 X 1.5 | M12 X 1.25 | 17 mm | Rs. 920 |
| RDS 1652 | Ace MEGA (DICOR ENGINE) (Both Side Adjustable) (Fitted with RDS 1103) (Pipe Length 25.5") (Pipe OD 28 mm) OE Part No. 552346600105 (For reference only) (1466) | M18 X 1.5 | M12 X 1.5 | 19 mm | Rs. 1,460 |
| RDS 1653 | Tata INTRA/Ace GOLD (Both Side Adjustable) (Fitted with RDS 1104) (Pipe Length 21") (Pipe OD 25 mm) | M16 X 1.5 | M12 X 1.25 | 17 mm | Rs. 1,100 |
| RDS 1654 | Leyland U Truck 4923 TT, 4023 TT (Pipe Length 32.5") (Pipe OD 60 mm) (1068) | M30 X 1.5 | M20 X 1.5 | 30 mm | Rs. 5,570 |
| RDS 1655 | Leyland IVECO 909 (One Side Fixed) (Pipe Length 38") (Pipe OD 50 mm) (Fitted with RDS 1207 Right Thread) (1015) | M30 X 1.5 | M20 X 1.5 | 30 mm | Rs. - |



| Part No. | Description | Housing Thread | Ball Pin Thread | Spanner Size  | LIST PRICE |
|----------|--|----------------|-----------------|--|------------|
| RDS 1656 | Eicher Canter N/M (Rane Type) 10.50, 10.59, 10.60, 10.60 G, 10.70, 10.75, 10.80, 10.90, 10.95, Double Bend (Pipe Length 25.5") (Pipe OD 32 mm) (Fitted with RDS 1051 RH) (708) | M20 X 1.5 | M14 X 1.5 | 22 mm | Rs. 2,620 |
| RDS 1657 | Eicher Canter 11.10 (Pipe Length 28") (Pipe OD 36 mm) (Fitted with RDS 1000 R) (719) | M24X 1.5 | M18 X 1.5 | 27 mm | Rs. 2,920 |
| RDS 1658 | Eicher Jumbo 20.25 FE, 30.25 XP, 33.25 20.15 / 5340 WBLP Cabin Model, 35.31 (Pipe Length 33.5") (Pipe OD 45 mm) (Fitted with RDS 1207 Right Thread) OE Part No. IA 203430 (For reference only) (723) | M30X 1.5 | M20 X 1.5 | 30 mm | Rs. 4,630 |
| RDS 1659 | Eicher Jumbo 20.16, 20.15, 33.25, 30.25, 30.25 FE 30.25 XD, TERRA 16, TERRA 16 XP (BS I, II, III) TERRA 16 HD, Galaxy 30.25 (Cabin/ COWL Model) (Pipe Length 50") (Pipe OD 50 mm) OE Ref. No. 114163020, IA208448 (726) | M30X 1.5 | M20 X 1.5 | 30 mm | Rs. 5,720 |
| RDS 1660 | Tata LPT 2518 TC (BS III), LPT 3118 TC (BS III) LPT 2518 COWL Body, LPT 3118 COWL Body (Pipe Length 46") (Pipe OD 60 mm) (Fitted with RDS 1215 Right Thread) OE Part No. 284946000113 (For reference only) (2422) | M30 X 1.5 | M20 X 1.5 | 30 mm | Rs. 6,680 |
| RDS 1661 | Tata Signa 1918K (BS VI), Signa 4018 (BS VI) Tata Signa 2823HD (BS VI), Signa 4625 (BS VI) (Pipe Length 25") (Pipe OD 50 mm) (Fitted with RDS 1175 Right Thread) OE Part No. 506946900101 (For reference only) (2453) | M40 X 1.5 | M24 X 1.25 | 36 mm | Rs. 4,780 |
| RDS 1662 | Mahindra NAVISTAR MN 25 Tipper, MN 31, MN 40 (Pipe Length 31") (Pipe OD 50 mm) (Fitted with RDS 1227 Right Thread) (1072) | M30 X 1.5 | M24 X 1.5 | 36 mm | Rs. 4,780 |
| RDS 1663 | Bharat Benz 3123 Tipper (Pipe Length 31.5") (Pipe OD 40 mm) (Fitted with RDS 1224 Right Thread) OE Part No. A4004600605 (For reference only) (2618) | M30 X 1.5 | M24 X 1.5 | 41 mm | Rs. 4,400 |



| Part No. | Description | Housing Thread | Ball Pin Thread | Spanner Size  | LIST PRICE |
|----------|---|-----------------------------------|-----------------|--|------------|
| RDS 1664 | Tata ULTRA 1412 (BS IV) (Pipe Length 33") (Pipe OD 50 mm) OE Part No. 552946900104 (For reference only) (2446) | M30 X 1.5 | M18 X 1.5 | 27 mm | Rs. 4,890 |
| RDS 1665 | Eicher PRO 60.25 (Pipe Length 32") (Pipe OD 50 mm) (Fitted with RDS 1207 Right Thread) OE Part No. IA307786 (For reference only) (1715) | M30X 1.5 | M20 X 1.5 | 30 mm | Rs. 4,630 |
| RDS 1666 | Tata 1616, 2416, 2516, 3516, 2213 TC, 2515 Ex (Pipe Length 28") (Pipe OD 50 mm) (Fitted with RDS 1202 Right Thread) (422) | M30X 1.5 | M18 X 1.5 | 27 mm | Rs. 4,160 |
| RDS 1667 | Tata ULTRA 1518 (BS III, BS IV) (Pipe Length 31.5") (Pipe OD 50 mm) (Fitted with RDS 1175) OE Part No. 553046600109 (For reference only) (2419) | M40X 1.5 | M24 X 1.5 | 36 mm | Rs. 5,050 |
| RDS 1668 | Leyland AVTR 2820 HG, 3520 HG, 4220 HG (PIPE LENGTH 35") (Pipe OD 60 mm) (Fitted with RDS 1224 Right Thread) OE Part No. FE602000 (For reference only) (2508) | M40 X 1.5 LH & M30 X 1.5 RH | M24 X 1.5 | 36 mm | Rs. 7,100 |
| RDS 1669 | Leyland AVTR 2820 HG, 3520 HG, 4220 HG (PIPE LENGTH 36") (Pipe OD 50 mm) (Fitted with RDS 1224 Right Thread) OE Part No. FE601900 (For reference only) (2509) | M38 X 1.5 LH & M30 X 1.5 RH | M24 X 1.5 | 36 mm | Rs. 7,100 |

*Many more
to come*



| Part No. | Description | Housing Thread | Ball Pin Thread | Spanner Size  | LIST PRICE |
|----------|--|----------------|-----------------|--|------------|
| RDS 1671 | Tata LPK 2518 HD (BS IV) Tipper, LPK 2523 TC (Pipe Length 5.12" / 130 mm) (Centre to Centre - 219 mm) OE Part No. 288032900101 (For Reference only) (666) | - | M24 X 1.5 | 36 mm | Rs. 2,730 |
| RDS 1672 | Tata 3118, 3718, Prima 2530 / 3130 LPK 3118 (Pipe Length 7.67" / 195 mm) (Centre to Centre - 292 mm) OE Part No. 501732800101 (For Ref. only) (2410) | - | M24 X 1.5 | 36 mm | Rs. 3,010 |
| RDS 1673 | Tata Signa 4221 BS VI / LPT 1618 BS IV, Signa 4223 BS IV / Signa 3118 BS IV (Pipe Length 11.4" / 290 mm) (Centre to Centre - 380 mm) (SAME DIRECTION) OE Part No. 501332800103 (For Ref. only) (2462) | - | M24 X 1.5 | 36 mm | Rs. 3,180 |
| RDS 1674 | Tata LPK 3118 TC BS III, LPK 3718 TC BS IV, Signa 3718 BS IV, Signa 4323 BS IV (Pipe Length 11.4" / 290 mm) (Centre to Centre - 380 mm) (OPPOSITE DIRECTION) OE Part No. 501332800101 (For Ref. only) (2408) | - | M24 X 1.5 | 36 mm | Rs. 3,180 |
| RDS 1675 | Tata Prima 2530 / 2523 / 3138 LPK, 2518 TC (Pipe Length 5.51" / 140 mm) (Centre to Centre - 234 mm) OE Part No. 5000632900101 (For Ref. only) (2409) | - | M24 X 1.5 | 36 mm | Rs. 2,730 |

*Many more
to come*





RDS 1228

Tie Rod End (Right Thread) **(PLUG TYPE)**
 Tata 3718 Signa, LPT 3118 (BS III)
 (with Thick Taper Ball Pin) (Housing Thread Size M30 x 1.5)
 (Ball Pin Thread M24 x 1.5) (Spanner Size 36 mm)

List Price Rs.1,340 Each



RDS 1229

Tie Rod End (Left Thread) **(PLUG TYPE)**
 Tata 3718 Signa, LPT 3118 (BS III)
 (with Thick Taper Ball Pin) (Housing Thread Size M30 x 1.5)
 (Ball Pin Thread M24 x 1.5) (Spanner Size 36 mm)

List Price Rs.1,340 Each



RDS 1230

Tie Rod End (Right Thread) **(PLUG TYPE)**
 Tata 3718 Signa, LPT 3118 (BS III) (Second Rod)
 (with Thin Taper Ball Pin) (Housing Thread Size M30 x 1.5)
 (Ball Pin Thread M24 x 1.5) (Spanner Size 36 mm)

List Price Rs.1,340 Each



RDS 1231

Tie Rod End (Left Thread) **(PLUG TYPE)**
 Tata 3718 Signa, LPT 3118 (BS III) (Second Rod)
 (with Thin Taper Ball Pin) (Housing Thread Size M30 x 1.5)
 (Ball Pin Thread M24 x 1.5) (Spanner Size 36 mm)

List Price Rs.1,340 Each



RDS 1233

Tie Rod End (Right Thread) **(PLUG TYPE)**
 Leyland U Truck 4923 TT, 4023 TT, 3518 TT
 (Housing Thread Size M30 x 1.5)
 (Ball Pin Thread M20 x 1.5) (Spanner Size 30 mm)

List Price Rs.1,000 Each



RDS 1234

Tie Rod End (Left Thread) **(PLUG TYPE)**
 Leyland U Truck 4923 TT, 4023 TT, 3518 TT
 (Housing Thread Size M30 x 1.5)
 (Ball Pin Thread M20 x 1.5) (Spanner Size 30 mm)

List Price Rs.1,000 Each



RDS 1232

Tie Rod End set (LH + RH) **(PLUG TYPE)**
Leyland U Truck 4923 TT, 4023 TT, 3518 TT
(Housing Thread Size M30 x 1.5)
(Ball Pin Thread M20 x 1.5) (Spanner Size 30 mm)

List Price Rs.1,960 Set

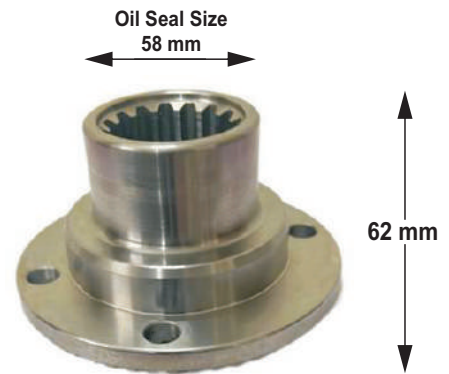

RDS 465

Gear Box Coupling Flange
Tata 1212 (16 Splines)
(Plate Size 4.7" / 120 mm, X Serrated)
(4 Holes) (Hole Dia 11.2 mm) (Bolt Size 18 No.)
(Total Height 62 mm) (Oil Seal Size 58 mm)

List Price Rs.910 Each

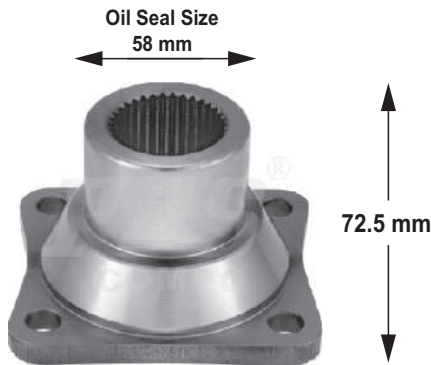

RDS 1301

Gear Box Flange
Eicher TERRA 16 (34 Splines)
Square Base (4 Holes)
(Hole Dia 12.8 mm) (Bolt Size 21 No.)
(Total Height 72.5 mm) (Oil Seal Size 58 mm)

List Price Rs.1,050 Each



RDS 233

Flange Yoke Cross Holder
Canter N/M (Plate size 4.7" / 120 mm, X Serrated)
(4 Holes) (Hole dia 11.2 mm) (Bolt Size 18 No.)
(Total Height 3.4" / 87 mm) (U J Cross Fitting RDS 6208)
(U J Dimensions 30.18 mm x 106 mm)

List Price : Rs.1,210 Each



RDS 576

Yoke & Teeth Set Mahindra Bolero FB MEGA
Pickup Extra Long (Flat Bed) **TEFLON COATED**
(16 Splines) (Cross Fitting Jeep Diesel, RDS 6210 A)
(U J Cross Dimensions 27 mm x 82 mm)
(Rear Teeth head size 60 mm) (Bearing Size 35 mm)
(MSL Ref. No. 322045037) **List Price Rs.2,060 Each**



RDS 6172 D

Stub Ball Half Yoke
Mahindra Maxi Truck (Head Size 66.2 mm)
(U J Cross Fitting RDS 6210 A, 27 mm x 82 mm)

List Price Rs.740 Each

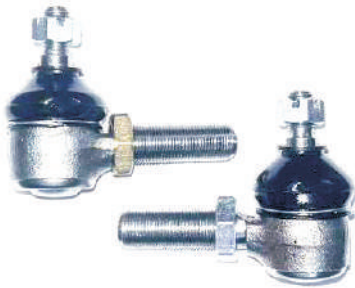

RDS 1103

Tie Rod End set (LH + RH)
 Tata Ace MEGA / Super Ace MINT
 Dicor Engine (Housing Thread Size M18 x 1.5)
 (Ball Pin Thread M12 x 1.5) (Spanner Size 19 mm)
OE Ref. No. 552333990101 / 102
List Price Rs.680 Set

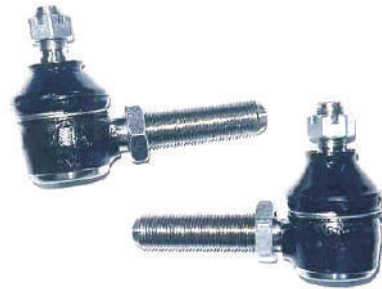

RDS 1104

Tie Rod End set (LH + RH)
 Tata INTRA V 10 / Ace GOLD / Mahindra SUPRO
 (Housing Thread Size M16 x 1.5)
 (Ball Pin Thread M12 x 1.25) (Spanner Size 19 mm)
OE Ref. No. 554533800106 / 107
List Price Rs.530 Set



RDS 1016

Tie Rod End set (LH + RH)
 Tata 410 / 407 Pick Up
 (Housing Thread Size M24 x 1.5)
 (Ball Pin Thread M12 x 1.5) (Spanner Size 19 mm)
List Price Rs.920 Set



RDS 1181

Drag Link End (Right Thread)
 Tata Signa 4923, 4018, LPT 3118, LPK 2518 TC, Tata 1518 Ultra
 Thread Size M40 x 1.5 (**Ball Pin Thread M18 x 1.5**) (Spanner Size 27 No.)
OE Part No. 219046900103 (For Ref. Only) (2448 A)
List Price Rs.1,290 Each



RDS 1226

Tie Rod End (Left Thread)
MAHINDRA NAVISTAR (MN 25 Tipper, MN 31, MN 40)
 (Housing Thread Size M30 x 1.5)
 (Ball Pin Thread M24 x 1.5) (Spanner Size 36 mm)
OE Ref. No. 7503AAP00100N
List Price Rs.1,120 Each



RDS 1227

Tie Rod End (**Right Thread**)
MAHINDRA NAVISTAR (MN 25 Tipper, MN 31, MN 40)
 (Housing Thread Size M30 x 1.5)
 (Ball Pin Thread M24 x 1.5) (Spanner Size 36 mm)
OE Ref. No. 7503AAP00101N
List Price Rs.1,120 Each



RDS 1063

Gear Shifter Ends (Right Thread)
Eicher Canter 10.50, 10.59, 10.60, 10.70,
10.75, 10.80, 10.90, 10.95
(Housing Thread Size M10 x 1.25)
(Ball Pin Thread M8 x 1.25) (Spanner Size 13 mm)
List Price Rs.286 Set



RDS 1064

Gear Shifter Ends (Right Thread)
Eicher Jumbo 20.16, 20.15, 30.25 FE, 33.25,
Terra 16, Galaxy 30.25 Cabin / COWL Model
(Housing Thread Size M10 x 1.25)
(Ball Pin Thread M10 x 1.25) (Spanner Size 13 mm)
List Price Rs.350 Set



RDS 1065

Gear Shifter Ends (Right Thread)
EICHER PRO
(Housing Thread Size M10 x 1.5)
(Ball Pin Thread M10 x 1.25) (Spanner Size 13 mm)
List Price Rs.365 Set



RDS 1214

Tie Rod End set (LH + RH)
Tata LPT 3118 TC (BS III), LPT 2518 TC (BS III),
LPT 3118 COWL Body, LPT 2518 COWL Body
(Heavy Duty, Long Body) (Fitted with 107 mm Long Ball Pin)
(Housing Thread Size M30 x 1.5)
(Ball Pin Thread M20 x 1.5) (Spanner Size 30 mm)
List Price Rs.2,240 Set



RDS 1215

Tie Rod End **(Right Thread)**
Tata LPT 3118 TC (BS III), LPT 2518 TC (BS III),
LPT 3118 COWL Body, LPT 2518 COWL Body
(Heavy Duty, Long Body) (Fitted with 107 mm Long Ball Pin)
(Housing Thread Size M30 x 1.5)
(Ball Pin Thread M20 x 1.5) (Spanner Size 30 mm)
List Price Rs.1,120 Each



RDS 1216

Tie Rod End (Left Thread)
Tata LPT 3118 TC (BS III), LPT 2518 TC (BS III),
LPT 3118 COWL Body, LPT 2518 COWL Body
(Heavy Duty, Long Body) (Fitted with 107 mm Long Ball Pin)
(Housing Thread Size M30 x 1.5)
(Ball Pin Thread M20 x 1.5) (Spanner Size 30 mm)
List Price Rs.1,120 Each

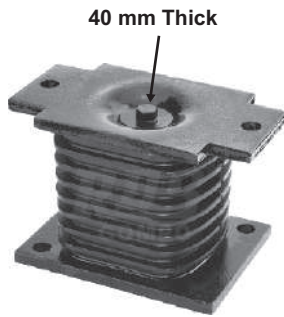

RDS HP 110

Rubber Hollow Pad
Tata 2518 / 2528 Tipper

(HEAVY DUTY) (with 40 mm thick bolt)

List Price Rs.4,100 Each



RDS HP 533

Rubber Hollow Pad / Load Cushion
Tata BS VI (Shorter Height - 110 mm)

(HEAVY DUTY) (with 40 mm thick bolt)

List Price Rs.



RDS 189

Cabin Mounting Set Tata 4018 TC
(with Nut Bolt & Washers)

List Price Rs.520 Each



RDS EM 344

Gear Box Mounting
LEYLAND DOST
(Heavy Duty)

List Price Rs.770 Each

*Many more
to come*



RDS 463

Gear Box Flange GB 950
Tata 2523, Leyland 3718 (28 Splines)
(Plate Size 6" / 150 mm)
(X Serrated - Diamond Cut) (4 Holes)
(Hole Dia 13 mm) (Bolt Size 19 No.)

(Total Height 60 mm) (Oil Seal Size 72 mm)

List Price Rs.1,650 Each

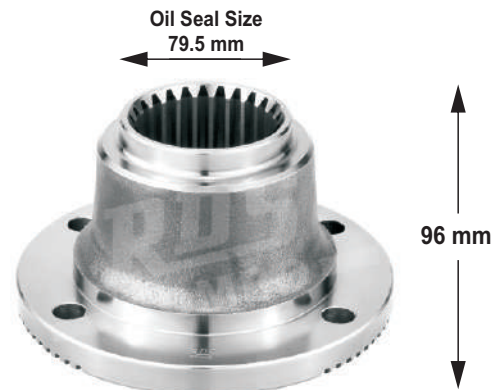

RDS 464

Centre Joint Flange (SPR 2060 Series)
Tata LPK 3128, 3138 (26 Splines)
(Plate Size 7" / 180 mm, X Serrated)
(4 Holes) (Hole Dia 15.2 mm) (Bolt Size 22 No.)

(Total Height 96 mm) (Oil Seal Size 79.5 mm)

List Price Rs.2,870 Each

SPR 2040 Series

(47.65 mm x 135 mm)

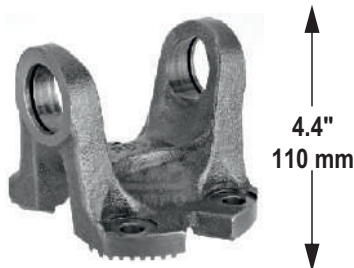

RDS 232

Tata 4928, 3128 Bharat Benz 2523 C (Big Plate)

(Plate size 7" / 180 mm, X Serrated)

(4 Holes) (Hole dia 15 mm)

(Bolt Size 22 No.) **(Total Height 4.4" / 110 mm)**

List Price : Rs.2,250



RDS 288

Lift Axle Bush Tata (16 Wheeler)

Hendrickson Model

(with Steel Pin & Washer)

(OD 151 mm, Height 172 mm)

List Price Rs.3,430 Each



RDS 285

Lift Axle Bush Tata 3718 (16 Wheeler)

(RSB Design) (Heavy Duty)

List Price Rs.3,025 Each



RDS 184

Cabin Leaf Spring Mounting

Tata Signa (Heavy Duty)

List Price Rs.580 Each



RDS 286
Cabin Mounting Bharat Benz (LEFT)
(With Heavy Duty Bracket)
List Price Rs.910 Each



RDS EM 848
Gear Box Mounting
Bharat Benz Trailer (BS-VI)
(Heavy Duty)
List Price Rs.4,200 Each



RDS 287
Cabin Mounting Bharat Benz (RIGHT)
(With Heavy Duty Bracket)
List Price Rs.910 Each



RDS EM 849
Front Engine Mounting
Tata 1512 Ultra (LEFT)
(With Heavy Duty Bracket)
List Price Rs.2,490 Each



RDS EM 850
Front Engine Mounting
Tata 1512 Ultra (RIGHT)
(With Heavy Duty Bracket)
List Price Rs.2,490 Each



RDS TRB 619
Torque Rod Bush Kit (Set of 2 pcs.)
Leyland (16 Wheeler)
(Outer Diameter 63 mm)
List Price Rs.1,590 Set

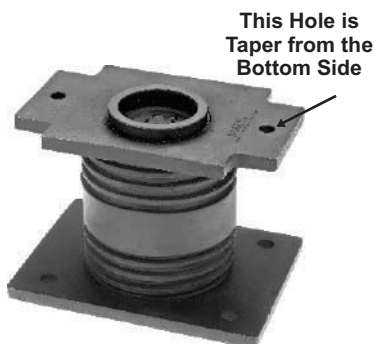

RDS HP 531
Rubber Hollow Pad
Eicher BS-VI **(with 12 mm Taper Holes)**
List Price Rs.4,400 Each



RDS HP 532
Rubber Hollow Pad
Bharat Benz (16 Wheeler)
(With Heavy Duty Bolt)
List Price Rs.3,680 Each



RDS TRB 620
V Rod Bush Tata 2518, 2523 Tipper / Tata Prima
For BS-VI Models (with 27 mm Round Hole)
List Price Rs.3,300 Each



RDS 371

Centre Bearing Bkt. (RSB Design)
(with Heavy Duty Patti)

Suitable for RDS 1827 R

List Price Rs.950 Each



RDS 372

Centre Bearing Bkt. (Spicer Design)
(Heavy Duty)

Suitable for RDS 1806

List Price Rs.780 Each



RDS 373

Centre Bearing Bkt. (MSL Design)
(with Heavy Duty Patti)

Suitable for RDS 1844

List Price Rs.1,110 Each



RDS 374

Centre Bearing Bkt. (Spicer Design)
(with Heavy Duty Patti)

Suitable for RDS 1842

List Price Rs.1,030 Each



RDS 375

Centre Bearing Bkt. 2416
(with Heavy Duty Patti)

Suitable for RDS 1802

List Price Rs..... Each



RDS 376

Centre Bearing Bkt. 2518
(with Heavy Duty Patti)

Suitable for RDS 1804

List Price Rs..... Each



RDS 377

Centre Bearing Bkt. 2516 / 2214
(with Heavy Duty Patti)

Suitable for RDS 1805

List Price Rs..... Each



RDS 1201

Tie Rod End Set (LH + RH)
Tata 2515 Ex (Plug Type)
Thread Size M30 x 1.5
Ball Pin Thread M18 x 1.5
(Spanner Size 27 No.)
List Price Rs.1,970 Set



RDS 1202

Drag Link End (**Right Thread**)
Tata 2515 Ex (Plug Type)
Thread Size M30 x 1.5
Ball Pin Thread M18 x 1.5
(Spanner Size 27 No.)
List Price Rs.960 Each



RDS 1203

Tie Rod End (Left Thread)
Tata 2515 Ex (Plug Type)
Thread Size M30 x 1.5
Ball Pin Thread M18 x 1.5
(Spanner Size 27 No.)
List Price Rs.960 Each



RDS 1206

Tie Rod End Set (LH + RH)
Tata / L/L 4018, Iveco 909 (Plug Type)
Eicher Jumbo 20.16 / Galaxy 30.25 / L/L FA-90
Thread Size M30 x 1.5
Ball Pin Thread M20 x 1.5
(Spanner Size 30 No.)
List Price Rs.1,900 Set



RDS 1207

Drag Link End (**Right Thread**)
Tata / L/L 4018, Iveco 909 (Plug Type)
Thread Size M30 x 1.5
Ball Pin Thread M20 x 1.5
(Spanner Size 30 No.)
List Price Rs.1,000 Each



RDS 1208

Tie Rod End (Left Thread)
Tata / L/L 4018, Iveco 909 (Plug Type)
Thread Size M30 x 1.5
Ball Pin Thread M20 x 1.5
(Spanner Size 30 No.)
List Price Rs.1,000 Each

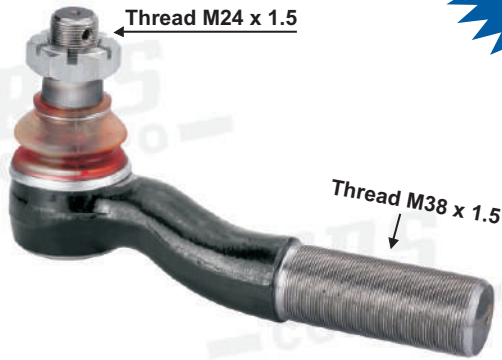

RDS 1209

Tie Rod End **(Right Thread)**
 Tata Prima, LPT 2518 (BS-III) (Bend Type)
 Thread Size M38 x 1.5
 Ball Pin Thread M24 x 1.5
 (Spanner Size 36 No.)
List Price Rs.2,030 Each

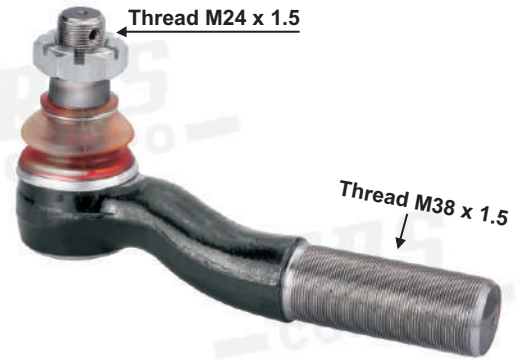

RDS 1210

Tie Rod End (Left Thread)
 Tata Prima, LPT 2518 (BS-III) (Bend Type)
 Thread Size M38 x 1.5
 Ball Pin Thread M24 x 1.5
 (Spanner Size 36 No.)
List Price Rs.2,030 Each



RDS 1212

Tie Rod End Set (LH + RH)
 Bharat Benz **(Long Rod)**
 Thread Size M30 x 1.5
 Ball Pin Thread M24 x 1.5
 (Spanner Size 36 No.)
List Price Rs.3,180 Set



RDS 1213

Tie Rod End Set (LH + RH)
 Bharat Benz (Short Rod)
 Thread Size M30 x 1.5
 Ball Pin Thread M24 x 1.5
 (Spanner Size 36 No.)
List Price Rs.2,240 Set



RDS 1222

Tie Rod End (**Right Thread**)
 Tata 3718 Signa, LPT 3118 (BS-III)
 (with Thick Taper Ball Pin)
 Thread Size M30 x 1.5
 Ball Pin Thread M24 x 1.5
 (Spanner Size 36 No.)
List Price Rs.1,120 Each



RDS 1223

Tie Rod End (Left Thread)
 Tata 3718 Signa, LPT 3118 (BS-III)
 (with Thick Taper Ball Pin)
 Thread Size M30 x 1.5
 Ball Pin Thread M24 x 1.5
 (Spanner Size 36 No.)
List Price Rs.1,120 Each



RDS 1224

Tie Rod End (**Right Thread**)
 Tata 3718 Signa, LPT 3118 (BS-III)
Second Rod (with Thin Taper Ball Pin)
 Thread Size M30 x 1.5
 Ball Pin Thread M24 x 1.5
 (Spanner Size 36 No.)
List Price Rs.1,120 Each



RDS 1225

Tie Rod End (Left Thread)
 Tata 3718 Signa, LPT 3118 (BS-III)
Second Rod (with Thin Taper Ball Pin)
 Thread Size M30 x 1.5
 Ball Pin Thread M24 x 1.5
 (Spanner Size 36 No.)
List Price Rs.1,120 Each



RDS 1181

Drag Link End (Right Thread)

Tata Signa 4923, 4018, LPT 3118, LPK 2518 TC, Tata 1518 Ultra

Thread Size M40 x 1.5 (Ball Pin Thread M18 x 1.5) (Spanner Size 27 No.)

OE Part No. 219046900103 (For Ref. Only) (2448 A)

List Price Rs.1,290 Each



RDS 1174

Drag Link End (Right Thread)

Tata Signa 4923, 4018, LPT 3118, LPK 2518 TC, Tata 1518 Ultra

Thread Size M40 x 1.5 (Ball Pin Thread M20 x 1.5)

(Spanner Size 30 No.) List Price Rs.1,330 Each



RDS 1175

Drag Link End (Right Thread)

Tata Signa 4923, 4018, LPT 3118, LPK 2518 TC, Tata 1518 Ultra

Thread Size M40 x 1.5 (Ball Pin Thread M24 x 1.5) (Spanner Size 36 No.)

OE Part No. 284646909901 (For Ref. Only) (2417 A)

List Price Rs.1,370 Each



RDS 1176

Drag Link End (Right Thread)

Tata Signa 4923, 4018, LPT 3118, LPK 2518 TC, Tata 1518 Ultra

Housing Thread M38 x 1.5 (Ball Pin Thread M18 x 1.5) (Spanner Size 27 No.)

OE Part No. 284646900107 (For Ref. Only) (2439 A)

List Price Rs.1,290 Each



RDS 1177

Drag Link End (Right Thread)

Tata Signa 4923, 4018, LPT 3118, LPK 2518 TC, Tata 1518 Ultra

Thread Size M38 x 1.5 (Ball Pin Thread M20 x 1.5)

(Spanner Size 30 No.) List Price Rs.1,330 Each



RDS 1178

Drag Link End (Right Thread)

Tata Signa 4923, 4018, LPT 3118, LPK 2518 TC, Tata 1518 Ultra

Housing Thread M38 x 1.5 (Ball Pin Thread M24 x 1.5) (Spanner Size 36 No.)

List Price Rs.1,370 Each

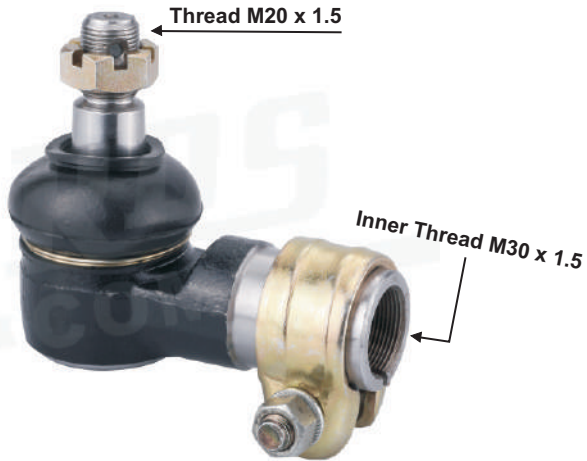

RDS 1173

Hydraulic Cylinder End / Ball Joint

Leyland 3116 / Eicher

Inner Thread Size M30 x 1.5

Ball Pin Thread M20 x 1.5

(Spanner Size 30 No.)

List Price Rs.1,370 Each



RDS 1179

Hydraulic Cylinder End / Ball Joint

Leyland U Truck / AMW

Inner Thread Size M30 x 1.5

Ball Pin Thread M24 x 1.5

(Spanner Size 36 No.)

List Price Rs.1,410 Each

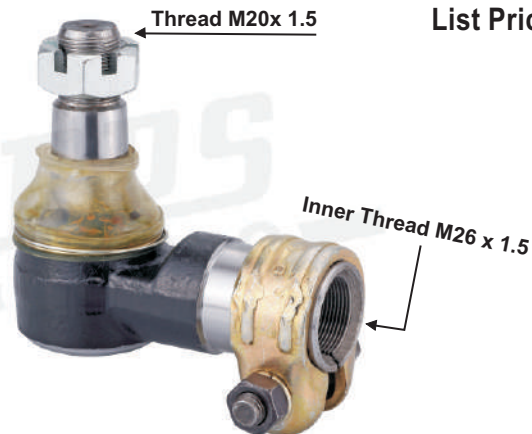

RDS 1180

Hydraulic Cylinder End / Ball Joint

Tata Prima 3128 (Right Thread)

Inner Thread Size M26 x 1.5

Ball Pin Thread M20 x 1.5

(Spanner Size 30 No.)

List Price Rs.1,370 Each

*Many more
to come*



RDS 1206

Tie Rod End Set (LH + RH)
 Eicher Jumbo 20.16 / Galaxy 30.25 / L/L FA-90
 Thread Size M30 x 1.5
 Ball Pin Thread M20 x 1.5
 (Spanner Size 30 No.)
List Price Rs.2,030 Set

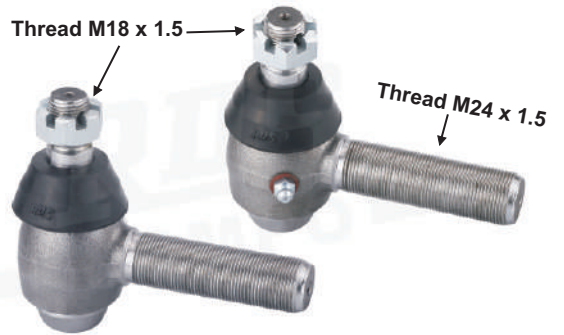

RDS 1000

Tie Rod End Set (LH + RH)
 Eicher 11.10 Pro
 Thread Size M24 x 1.5
 Ball Pin Thread M18 x 1.5
 (Spanner Size 27 No.)
List Price Rs.1,250 Set



RDS 1051

Tie Rod End Set (LH + RH)
 Eicher Canter N/M (Plug Type)
 Thread Size M20 x 1.5
 Ball Pin Thread M14 x 1.5
 (Spanner Size 22 No.)
List Price Rs.1,280 Set



RDS 1061

Tie Rod End Set (LH + RH)
 Eicher 11.10
 Thread Size M20 x 1.5
 Ball Pin Thread M18 x 1.5
 (Spanner Size 27 No.)
List Price Rs.1,230 Set

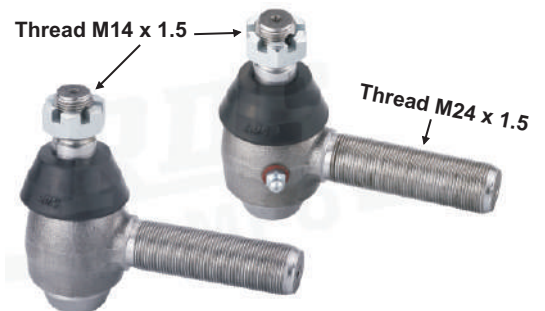

RDS 1062

Tie Rod End Set (LH + RH)
 Eicher 10.80 / 10.95
 Housing Thread Size M24 x 1.5
 Ball Pin Thread M14 x 1.5
 (Spanner Size 27 No.)
List Price Rs.1,230 Set



RDS 1214

Tie Rod End Set (LH + RH)
Tata Prima 3123 T, 3118 (BS-III) (Heavy Duty)
Thread Size M30 x 1.5

Fitted with 107 mm long Ball Pin

Ball Pin Thread M20 x 1.5
(Spanner Size 30 No.)

List Price Rs.2,240 Set



RDS 1000

Tie Rod End Set (LH + RH)
Tata 1210, 1312 / Eicher 11.10 Pro
Thread Size M24 x 1.5
Ball Pin Thread M18 x 1.5
(Spanner Size 27 No.)

List Price Rs.1,250 Set



RDS 1000 R

Tie Rod End (**Right Thread**)
Tata 1210, 1312 / Eicher 11.10 Pro
Thread Size M24 x 1.5
Ball Pin Thread M18 x 1.5
(Spanner Size 27 No.)

List Price Rs.715 Each



RDS 1000 L

Tie Rod End (Left Thread)
Tata 1210, 1312 / Eicher 11.10 Pro
Thread Size M24 x 1.5
Ball Pin Thread M18 x 1.5
(Spanner Size 27 No.)

List Price Rs.715 Each

New Introduction



RDS 751

Pump Coupling Shaft
Escorts Hydra
Total compressed Length 10.5" / 265 mm
Flange Dia 86 mm
UJ Dimensions 23.83 mm x 61.2 mm
List Price Rs.3,800 Each

New Introduction



RDS 752

Rear Transmission Shaft
JCB 3DX
UJ Dimensions 34.95 mm x 106 mm
List Price Rs.5,290 Each



RDS 753

Cut Yoke Assembly
John Deere Tractor / Hydra
Flange Dia 86 mm
UJ Dimensions 23.83 mm x 61.2 mm
List Price Rs.2,980 Set

New Introduction

FLANGE YOKE / CROSS HOLDER

RSB 620 Series SPR 2055

(57 mm x 152 mm)



RDS 1721

Tata 1628, 2038, 3138 Long
Leyland 3936, Bharat Benz 2528 C
(Plate size 7" / 180 mm, X Serrated)
(4 Holes) (Hole dia 15 mm)
(Bolt Size 22 No.)
(Total Height 5.25" / 133 mm)

List Price : Rs.2,880

RSB 590 Series SPR 2045, 2047 Series

(52 mm x 147 mm)



RDS 1731

Tata LPS 4028, LPK 3128,
Bharat Benz 2523 C (SMALL)
Leyland 3123 (Steel Forged)
(Plate size 7" / 180 mm, X Serrated)
(4 Holes) (Hole dia 15 mm)
(Bolt Size 22 No.)
(Total Height 5" / 125 mm)

List Price : Rs.2,665

RSB 590 Series SPR 2045, 2047 Series

(52 mm x 147 mm)



RDS 1795

Tata LPS 4028, LPK 3128 (LONG)
Bharat Benz 2523 C, Leyland 3123
(Plate size 7" / 180 mm, X Serrated)
(4 Holes) (Hole dia 15 mm)
(Bolt Size 22 No.)

(Total Height 5.5" / 140 mm)

List Price : Rs.2,500

RSB 590 Series SPR 2045, 2047 Series

(52 mm x 147 mm)



RDS 1732

Tata LPS 4028, LPK 3128,
Bharat Benz 2523 C (SMALL)
Leyland 3123 (Steel Forged)
(Plate size 6" / 150 mm, X Serrated)
(4 Holes) (Hole dia 13 mm)
(Bolt Size 19 No.)
(Total Height 5" / 125 mm)

List Price : Rs.2,380

RSB 590 Series SPR 2045, 2047 Series

(52 mm x 147 mm)



RDS 1737

Tata LPS 4028, LPK 3128,
Bharat Benz 2523 C,
Leyland 3123 (Steel Forged) (LONG)
(Plate size 6" / 150 mm, X Serrated)
(4 Holes) (Hole dia 13 mm)
(Bolt Size 19 No.)

(Total Height 5.5" / 140 mm)

List Price : Rs.2,400

SPR 2040 Series

(47.65 mm x 135 mm)



RDS 1701

Tata 4928, 3128,
Bharat Benz 2523 C (LONG)
(Steel Forged)
(Plate size 6" / 150 mm, X Serrated)
(4 Holes) (Hole dia 13 mm)
(Bolt Size 19 No.)
(Total Height 5.4" / 138 mm)

List Price : Rs.2,240

SPR 2040 Series

(47.65 mm x 135 mm)

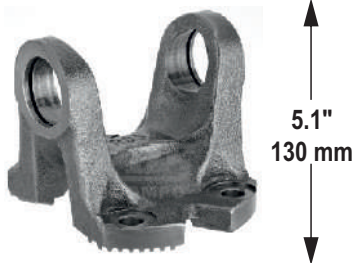

5.1"
130 mm

RDS 1702

Tata 4928, 3128

Bharat Benz 2523 C (Big Plate)

(Plate size 7" / 180 mm, X Serrated)

(4 Holes) (Hole dia 15 mm)

(Bolt Size 22 No.)

(Total Height 5.1" / 130 mm)

List Price : Rs.2,330

SPR 2040 Series

(47.65 mm x 135 mm)



4.65"
118 mm

RDS 1707

Tata 4928, 3128,

Bharat Benz 2523 C (SHORT)

(Steel Forged)

(Plate size 6" / 150 mm, X Serrated)

(4 Holes) (Hole dia 13 mm)

(Bolt Size 19 No.)

(Total Height 4.65" / 118 mm)

List Price : Rs.1,990

RSB 490 Series

(48 mm x 135 mm)

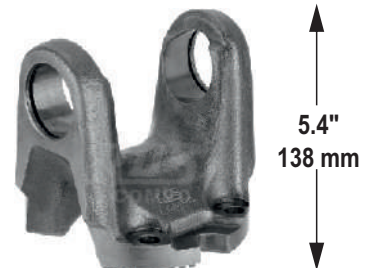

5.4"
138 mm

RDS 149

Tata 4018 / 3118 (LONG)

(Steel Forged)

(Plate size 6" / 150 mm, X Serrated)

(4 Holes) (Hole dia 13 mm)

(Bolt Size 19 No.)

(Total Height 5.4" / 138 mm)

List Price : Rs.2,240

RSB 490 Series

(48 mm x 135 mm)



4.65"
118 mm

RDS 149 S

Tata 4018 / 3118 (SHORT)

(Steel Forged)

(Plate size 6" / 150 mm, X Serrated)

(4 Holes) (Hole dia 13 mm)

(Bolt Size 19 No.)

(Total Height 4.65" / 118 mm)

List Price : Rs.1,860

RSB 490 Series

(48 mm x 135 mm)



4.9"
125 mm

RDS 711

Tata 4018 / 3118

(Plate size 6.5" / 165 mm, Plain Base)

(8 Holes) (Hole dia 16.2 mm)

(Bolt Size 24 No.)

(Total Height 4.9" / 125 mm)

List Price : Rs.2,460

RSB 490 Series

(48 mm x 135 mm)



5"
128 mm

RDS 713

Tata 4018 / 3118 (Big Plate)

(Plate size 7" / 180 mm, X Serrated)

(4 Holes) (Hole dia 15 mm)

(Bolt Size 22 No.)

(Total Height 5" / 128 mm)

List Price : Rs.2,570

Tata 4018 Patti Type

(49.20 mm x 135 mm)



4.7"
119 mm

RDS 146 A

Tata 3118, 4018 / AMW 2518, MAN 25 T

(Plate size 7" / 180 mm, X Serrated)

(4 Holes) (Hole dia 15 mm)

(Bolt Size 22 No.)

(Total Height 4.7" / 119 mm)

List Price : Rs.2,650

Tata 4018 Patti Type

(49.20 mm x 135 mm)



4.7"
119 mm

RDS 146

Tata 3118, 4018 / AMW 2518, MAN 25 T

(Steel Forged)

(Plate size 6" / 150 mm, X Serrated)

(4 Holes) (Hole dia 13 mm)

(Bolt Size 19 No.)

(Total Height 4.7" / 119 mm)

List Price : Rs.2,490

Tata 4018 Patti Type

(49.20 mm x 135 mm)



4.8"
122 mm

RDS 1774

Tata 311, 4018 / AMW 2518,

MAN 25 T

(Plate size 6" / 150 mm, X Serrated)

(4 Holes) (Hole dia 13 mm)

(Bolt Size 19 No.)

(Total Height 4.8" / 122 mm)

List Price : Rs.2,490

Tata 4018 Patti Type

(49.20 mm x 135 mm)



4.6"
117 mm

RDS 714

Tata 4018 / AMW 2518 / Eicher 40.25

(Plate size 8" / 203 mm, Plain Base)

(12 Holes) (Hole dia 10.5 mm)

(Bolt Size 19 No.)

(Total Height 4.6" / 117 mm)

List Price : Rs.3,400

Tata 4018 Patti Type

(49.20 mm x 135 mm)



5.4"
136 mm

RDS 144

Cross Holder Tata 4018

(Patti Type) (Plate Size 165 mm)

(8 Holes) (Hole Dia 16.2 mm)

(Bolt Size 24 No.)

(Total Height 5.4" / 136 mm)

List Price : Rs.2,540

RSB 403 Series

(42 mm x 129.35 mm)



4.3"
110 mm

RDS 192

Tata 2515 / 2518 Short

(Steel Forged)

(Plate size 6" / 150 mm, X Serrated)

(4 Holes) (Hole dia 13 mm)

(Bolt Size 19 No.)

(Total Height 4.3" / 110 mm)

List Price : Rs.1,800

RSB 403 Series

(42 mm x 129.35 mm)

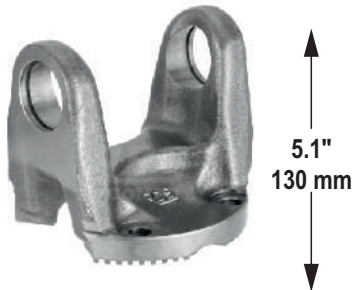

RDS 193

Tata 2515 / 2518 Long
(Steel Forged)
(Plate size 6" / 150 mm, X Serrated)
(4 Holes) (Hole dia 13 mm)
(Bolt Size 19 No.)
(Total Height 5.1" / 130 mm)
List Price : Rs.1,920

RSB 403 Series

(42 mm x 129.35 mm)

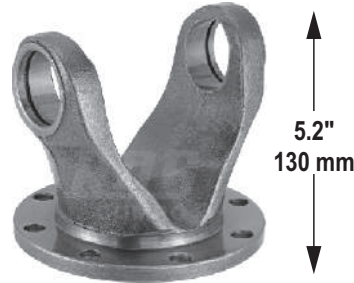

RDS 1771

Tata 2518 N/M
(Plate size 6" / 150 mm, Plain Base)
(6 Holes) (Hole dia 12.1 mm)
(Bolt Size 19 No.)
(Total Height 5.2" / 130 mm)
List Price : Rs.1,654

RSB 403 Series

(42 mm x 129.35 mm)

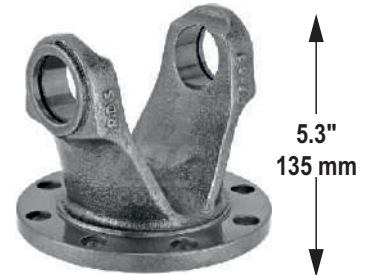

RDS 161

Tata 2515 / 2518 (Big Plate)
(Plate size 6.5" / 165 mm, Plain Base)
(8 Holes) (Hole dia 16.2 mm)
(Bolt Size 24 No.)
(Total Height 5.3" / 135 mm)
List Price : Rs.2,260

RSB 403 Series

(42 mm x 129.35 mm)



RDS 712

Leyland 2518 / 2214
(Plate size 7" / 175 mm, Plain Base)
(8 Holes) (Hole dia 9.8 mm)
(Bolt Size 15 No.)
(Total Height 5.3" / 134 mm)
List Price : Rs.2,060

SPL 90 Series

(41.28 mm x 126 mm)



RDS 191

Tata 3118 / Leyland 3116, 1616 (SHORT)
(Steel Forged)
(Plate size 6" / 150 mm, X Serrated)
(4 Holes) (Hole dia 13 mm)
(Bolt Size 19 No.)
(Total Height 4.3" / 110 mm)
List Price : Rs.1,800

SPL 90 Series

(41.28 mm x 126 mm)



RDS 231

Tata 3118 / Leyland 3116, 1616 (MEDIUM)
(Steel Forged)
(Plate size 6" / 150 mm, X Serrated)
(4 Holes) (Hole dia 13 mm)
(Bolt Size 19 No.)
(Total Height 4.65" / 118 mm)
List Price : Rs.2,050

SPL 90 Series

(41.28 mm x 126 mm)

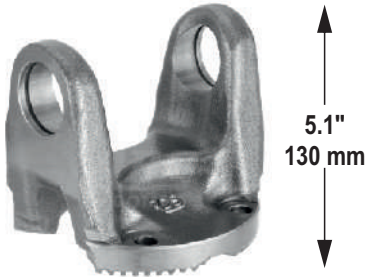

5.1"
130 mm

RDS 191 A

Tata 3118 / Leyland 3116, 1616 (LONG)
(Steel Forged)

(Plate size 6" / 150 mm, X Serrated)
(4 Holes) (Hole dia 13 mm)
(Bolt Size 19 No.)

(Total Height 5.1" / 130 mm)

List Price : Rs.2,050

SPL 90 Series

(41.28 mm x 126 mm)



4.5"
114 mm

RDS 006 A

Tata 2515 Hywa
(Plate size 5.1" / 130 mm, Plain Base)

(8 Holes) (Hole dia 10.2 mm)
(Bolt Size 17 No.)
(Total Height 4.5" / 114 mm)

List Price : Rs.1,636

SPL 90 Series

(41.28 mm x 126 mm)



4.5"
114 mm

RDS 6231 D

Cross Holder L/L 2516/2214

(Plate size 7" / 175 mm, Plain Base)

(8 Holes) (Hole Dia 9.8 mm)
(Bolt Size 15 No.)
(Total Height 4.5" / 114 mm)

List Price : Rs.1,950

SPL 90 Series

(41.28 mm x 126 mm)

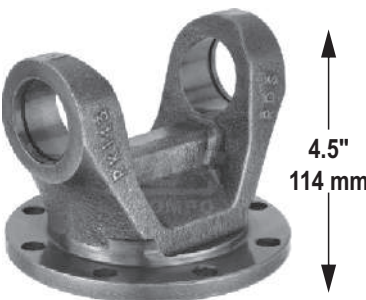

4.5"
114 mm

RDS 113

Tata 2518
(Plate size 6" / 150 mm, Plain Base)

(8 Holes) (Hole dia 12.2 mm)
(Bolt Size 19 No.)
(Total Height 4.5" / 114 mm)

List Price : Rs.1,950

SPL 90 Series

(41.28 mm x 126 mm)

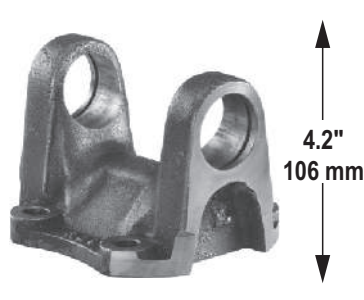

4.2"
106 mm

RDS 133

Cross Holder Inter Axle Shaft
(Extra Long Height)

(Square Base)
(4 Holes) (Hole Dia 12.8 mm)
(Bolt Size 21 No.)
(Total Height 4.2" / 106 mm)

List Price : Rs.1,560

RSB 325 Series

(42 mm x 119 mm)

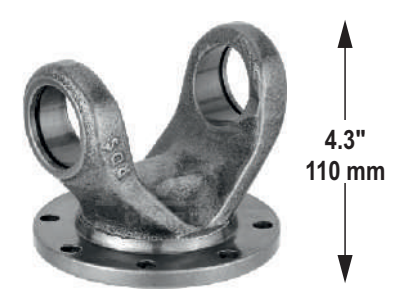

4.3"
110 mm

RDS 112

Tata 2515 Ex (Big Nut)
(Plate size 5.1" / 130 mm, Plain Base)

(8 Holes) (Hole dia 10.2 mm)
(Bolt Size 17 No.)
(Total Height 4.3" / 110 mm)

List Price : Rs.1,534

RSB 325 Series
(42 mm x 119 mm)

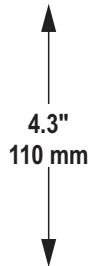

RDS 112 M

Tata 2515 Ex

(Plate Size 6" / 150 mm, Plain Base)

(8 Holes) (Hole Dia 12.2 mm)

(Bolt Size 19 No.)

(Total Height 4.3" / 110 mm)

List Price : Rs.1,645

RSB 325 Series
(42 mm x 119 mm)



RDS 112 C

Tata 2515 / 2518 Short

(Steel Forged)

(Plate size 6" / 150 mm, X Serrated)

(4 Holes) (Hole dia 13 mm)

(Bolt Size 19 No.)

(Total Height 4.3" / 110 mm)

List Price : Rs.1,830

RSB 325 Series
(42 mm x 119 mm)

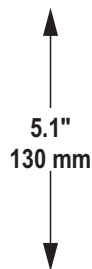

RDS 1791

Tata 2515 / 2518 Long

(Plate size 6" / 150 mm, X Serrated)

(4 Holes) (Hole dia 13 mm)

(Bolt Size 19 No.)

(Total Height 5.1" / 130 mm)

List Price : Rs.2,050

RSB 325 Series
(42 mm x 119 mm)

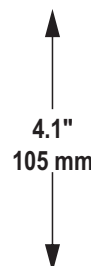

RDS 112 E

Tata 2515 Ex (Small Plate)

(Plate size 5.1" / 130 mm, X Serrated)

(4 Holes) (Hole dia 11 mm)

(Bolt Size 18 No.)

(Total Height 4.1" / 105 mm)

List Price : Rs.1,470

U.J. Cross Fitting Tata 1312
(46.05 mm x 69 mm)



RDS 6037

Tata 1312/1612/1510/2416

(Plate Size 5.1" / 130 mm Plain Base)

(8 Holes) (Hole Dia 10.2 mm)

(Bolt Size 17 No.)

(Total Height 4.6" / 116 mm)

List Price : Rs.1,520

U.J. Cross Fitting Tata 1312

(46.05 mm x 69 mm)

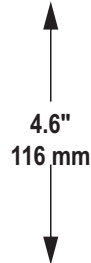

RDS 6037 A

Tata 1312/1612/1510/2416

(Plate Size 4.7" / 120 mm Plain Base)

(6 Holes) (Hole Dia 10.2 mm)

(Bolt Size 17 No.)

(Total Height 4.6" / 116 mm)

List Price : Rs.1,520

U.J. Cross Fitting L/Taskar

(34.95 mm x 126 mm)



RDS 6143

Leyland Taskar

(Square Base)

(4 Holes) (Hole dia 12.8 mm)

(Bolt Size 21 No.)

(Total Height 3.1" / 78 mm)

List Price : Rs.1,050

U.J. Cross Fitting L/Taskar

(34.95 mm x 126 mm)



RDS 6236

Tata 2515 TC/ L/L 2516

(Suitable for Inter Axle Shaft)

(Square Base)

(4 Holes) (Hole Dia 12.8 mm)

(Bolt Size 21 No.)

(Total Height 4.2" / 106 mm)

List Price : Rs.1,280

U.J. Cross Fitting L/Taskar

(34.95 mm x 126 mm)

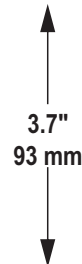

RDS 160

Eicher Terra, Tata / L/L 1710 Series

(Plate size 6" / 150 mm, X Serrated)

(4 Holes) (Hole dia 13 mm)

(Bolt Size 19 No.)

(Total Height 3.7" / 93 mm)

List Price : Rs.1,740

U.J. Cross Fitting L/Taskar

(34.95 mm x 126 mm)

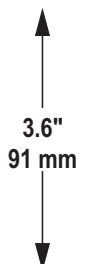

RDS 1779

Leyland Iveco

(Plate size 4.7" / 120 mm, X Serrated)

(4 Holes) (Hole dia 11.2 mm)

(Bolt Size 18 No.)

(Total Height 3.6" / 91 mm)

List Price : Rs.1,425

U.J. Cross Fitting L/Taskar

(34.95 mm x 126 mm)

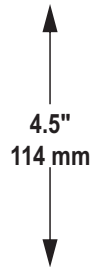

RDS 401

Tata 1109 N/M
 (Plate size 5.1" / 130 mm, Plain Base)
 (8 Holes) (Hole dia 10.2 mm)
 (Bolt Size 17 No.)
 (Total Height 4.5" / 114 mm)
List Price : Rs.1,450

U.J. Cross Fitting L/Taskar

(34.95 mm x 126 mm)



RDS 404

Tata 712, 412 / Marco Polo
 (Plate size 4.7" / 120 mm, Plain Base)
 (6 Holes) (Hole dia 10.2 mm)
 (Bolt Size 17 No.)
 (Total Height 3.5" / 89 mm)
List Price : Rs.1,305

U.J. Cross Fitting L/L 370

(39.69 mm x 116 mm)

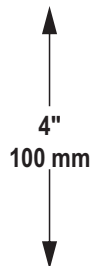

RDS 6129

Leyland 370 / Bedford
 (Plate size 6" / 146 mm, Plain Base)
 (4 Holes) (Hole dia 12.8 mm)
 (Bolt Size 21 No.)
 (Total Height 4" / 100 mm)
List Price : Rs.1,445

U.J. Cross Fitting L/L 370

(39.69 mm x 116 mm)

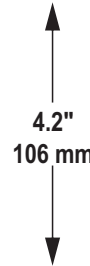

RDS 6237 B

Cross Holder Inter Axle Shaft
 (Extra Long Height)
 (Square Base)
 (4 Holes) (Hole Dia 12.8 mm)
 (Bolt Size 21 No.)
 (Total Height 4.2" / 106 mm)
List Price : Rs.1,560

MSL 1480 Series

(34.95 mm x 106 mm)



RDS 202

Tata 407 Pick Up
 (Plate size 4.7" / 120 mm, Plain Base)
 (6 Holes) (Hole dia 10.2 mm)
 (Bolt Size 17 No.)
 (Total Height 3.4" / 85 mm)
List Price : Rs.990

MSL 1480 Series
(34.95 mm x 106 mm)

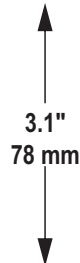

RDS 209

Tata 407 Pick Up N/M
(Square Base)
(4 Holes) (Hole dia 12.8 mm)
(Total Height 3.1" / 78 mm)
List Price : Rs.995

MSL 1480 Series
(34.95 mm x 106 mm)



RDS 1775

Tata 909, 709 / Eicher PRO
(Plate size 4.7" / 120 mm, X Serrated)
(4 Holes) (Hole dia 11.2 mm)
(Bolt Size 18 No.)
(Total Height 3.4" / 87 mm)
List Price : Rs.1,210

U.J. Cross Fitting Tata 407
(30 mm x 82 mm)

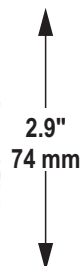

RDS 6058

Tata 407
(Plate size 4" / 100 mm, Plain Base)
(6 Holes) (Hole dia 8.1 mm)
(Bolt Size 13 No.)
(Total Height 2.9" / 74 mm)
List Price : Rs.720

U.J. Cross Fitting Canter N/M
(30.18 mm x 106 mm)

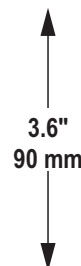

RDS 136

Tata 407 Turbo, 709 Ex
(Plate size 4.7" / 120 mm, Plain Base)
(6 Holes) (Hole dia 10.2 mm)
(Bolt Size 17 No.)
(Total Height 3.6" / 90 mm)
List Price : Rs.990

U.J. Cross Fitting DCM N/M
(30.18 mm x 92 mm)



RDS 715

Tata 407 Turbo N/M
(Plate size 4" / 100 mm, Plain Base)
(6 Holes) (Hole dia 8.1 mm)
(Bolt Size 13 No.)
(Total Height 2.75" / 70 mm)
List Price : Rs.890



| Part No. | U.J. Cross Dimensions | Head Size | Total Height | Application | List Price |
|------------|--|--------------|--------------|---|-----------------|
| RDS 112 A | RSB 325 Series (42 mm x 119 mm) (RDS 117) | 3.5" / 85 mm | 127 mm | Tata 2515 Ex / 1613 Turbo (STEEL FORGED) | Rs.1,860 |
| RDS 112 B | RSB 325 Series (42 mm x 119 mm) (RDS 117) | 4" / 95 mm | 130 mm | Tata 2515 Ex (Heavy Duty, STEEL FORGED) | Rs.1,860 |
| RDS 121 A | RSB 403 Series (42 mm x 129.35 mm) (RDS 121 M) | 4" / 95 mm | 139 mm | Tata 2515 / 2518 (Short) (STEEL FORGED) | Rs.1,990 |
| RDS 156 | RSB 403 Series (42 mm x 129.35 mm) (RDS 121 M) | 4" / 95 mm | 146 mm | Tata 2515 Hywa (with LONG LEGS) (STEEL FORGED) | Rs.1,990 |
| RDS 149 B | RSB 490 Series (48 mm x 135 mm) (RDS 111 / RDS 111 GL) | 4" / 95 mm | 142 mm | Tata 4018 / 3118 (Heavy Duty, STEEL FORGED) | Rs.2,220 |
| RDS 143 | Tata 4018 (49.2 mm x 155 mm) (RDS 601) | 4" / 95 mm | 137 mm | Tata 4018 Patti Type (Heavy Duty, STEEL FORGED) | Rs.2,220 |
| RDS 6231 E | SPL 90 Series (41.28 mm x 126 mm) (RDS 6202 H) | 4" / 95 mm | 130 mm | Leyland 2214, 2516 / Tata 2515 (Heavy Duty, STEEL FORGED) | Rs.1,860 |
| RDS 1772 | SPL 90 Series (41.28 mm x 126 mm) (RDS 6202 H) | 4" / 95 mm | 139 mm | Leyland 2214 N/M (with LONG LEGS) (Heavy Duty, STEEL FORGED) | Rs.1,870 |







| Part No. | U.J. Cross Dimensions | Head Size | Total Height | Application | List Price |
|----------|--|----------------|--------------|---|-----------------|
| RDS 1777 | SPL 90 Series (41.28 mm x 126 mm) (RDS 6202 H) | 3.5" / 85 mm | 130 mm | Tata LPK 2516 / 1615 (Heavy Duty, STEEL FORGED) | Rs.1,860 |
| RDS 1703 | SPR 2040 Series (47.65 mm x 135 mm) (RDS 6202 G/ 907 GL) | 4" / 95 mm | 148 mm | Tata 4928, 3128, L/L 3119, Bharat Benz (Heavy Duty, STEEL FORGED) | Rs.2,040 |
| RDS 1710 | SPR 2040 Series (47.65 mm x 135 mm) (RDS 6202 G/ 907 GL) | 3.6" / 91.4 mm | 148 mm | Tata 4928, 2528,3128, Bharat Benz (Heavy Duty, STEEL FORGED) | Rs.2,040 |
| RDS 1778 | SPR 2040 Series (47.65 mm x 135 mm) (RDS 6202 G/ 907 GL) | 4.5" / 112 mm | 140 mm | Tata 4928, 3128, L/L 3119, Bharat Benz (Heavy Duty, STEEL FORGED) | Rs.2,340 |
| RDS 1735 | RSB 590 / SPR 2045 Series (52 mm x 147 mm) (RDS 218/ 218 GL) | 4.5" / 112 mm | 160 mm | Tata LPS 4028, LPK 3128, L/L 3123, Bharat Benz (Heavy Duty, STEEL FORGED) | Rs.2,670 |
| RDS 1736 | RSB 590 / SPR 2045 Series (52 mm x 147 mm) (RDS 218/ 218 GL) | 4" / 95 mm | 160 mm | Tata LPS 4028, LPK 3128, L/L 3123, Bharat Benz (Heavy Duty, STEEL FORGED) | Rs.2,670 |
| RDS 1722 | RSB 620 / SPR 2055 Series (57 mm x 152 mm) (RDS 219) | 4.5" / 112 mm | 160 mm | Tata 1628, 2038, L/L 4936, Bharat Benz (Heavy Duty, STEEL FORGED) | Rs.2,810 |
| RDS 1773 | MSL 1480 Series, (35 mm x 106 mm) (RDS 201 / 217) | 3" / 72 mm | 92 mm | Tata 407 Pick Up (STEEL FORGED) | Rs.1,035 |

Propeller Shaft Components

STUB HALF YOKE / TUBE YOKE



| Part No. | U.J. Cross Dimensions | Head Size | Total Height | Application | List Price | |
|------------|--|--------------|--------------|--|-----------------|---|
| RDS 204 | MSL 1480 Series, (35 mm x 106 mm) (RDS 201 / 217) | 3.5" / 85 mm | - | Tata 407 Pick Up (STEEL FORGED) | Rs.1,780 | |
| RDS 6258 A | DCM N/M (30.18 mm x 92 mm) (RDS 6212) | 3" / 71 mm | - | TATA 407 Turbo (Type 3) (MSL Type) (Suitable with Yoke & Teeth RDS 6069 C) | Rs.795 |  |
| RDS 6038 | TATA 1312 (46.05 mm x 118 mm) (RDS 6201 A) | 3.5" / 85 mm | - | TATA 1312/1612/2416 (90 mm) | Rs.1,560 |  |
| RDS 6253 | Eicher Canter N/M (30.18 mm x 106 mm) (RDS 6208) | 3" / 71 mm | - | TATA 407 EX/Turbo (Type 2) / Canter N/M (Suitable with Yoke & Teeth RDS 6069 B) | Rs.730 |  |
| RDS 6231 N | Leyland Tusker (34.95 mm x 126 mm) (RDS 6202 B) | 4" / 95 mm | - | Inter Axle Shaft TATA/L/L 1710 Series/L/L 2516 Tipper | Rs.1,495 |  |
| RDS 6226 | L/L Taurus (Circlip Design) (47.65 mm x 135 mm) (RDS 6202 G) | 3.5" / 85 mm | - | L/L Taurus/3516 | Rs.2,220 |  |
| | | | | | | |
| | | | | | | |

10 Splines



RDS 6254

Centre Joint Flange
Eicher Canter 10.40, 10.70, 10.90 (10 Splines)
(Square Base) (4 Holes)
(Hole Dia 12.2 mm) (Bolt Size 21 No.)
(Total Height 62 mm) (Oil Seal Size 50 mm)

Mating Front Teeth RDS 6254 C

List Price : Rs.730

14 Splines



RDS 6254 A

Differential Coupling Flange
Eicher Canter 10.40, 10.60 LCV (14 Splines)
(Square Base) (4 Holes)
(Hole Dia 12.2 mm) (Bolt Size 21 No.)
(Total Height 60 mm) (Oil Seal Size 52 mm)

List Price : Rs.730

14 Splines



RDS 6254 D

Differential Coupling Flange
Eicher 10.90 LCV (14 Splines)
(Round Base) (4 Holes)
(Hole Dia 12.2 mm) (Bolt Size 21 No.)
(Total Height 67 mm) (Oil Seal Size 56 mm)

List Price : Rs.860

18 Splines



RDS 6271

Differential Coupling Flange
Eicher 11.10 XP HCV (18 Splines)
(Round Base) (4 Holes)
(Hole Dia 12.2 mm) (Bolt Size 21 No.)
(Total Height 67 mm) (Oil Seal Size 56 mm)

List Price : Rs.860

18 Splines



RDS 6255

Gear Box Coupling Flange
Eicher 10.40, 10.60, 10.90 LCV (18 Splines)
(Square Base Cut Type) (4 Holes)
(Hole Dia 12.2 mm) (Bolt Size 21 No.)
(Total Height 103 mm) (Oil Seal Size 48 mm)

List Price : Rs.970

20 Splines



RDS 462

Gear Box Coupling Flange
Eicher 11.10 (20 Splines)
(Square Base Cut Type) (4 Holes)
(Hole Dia 12.2 mm) (Bolt Size 21 No.)
(Total Height 103 mm) (Oil Seal Size 48 mm)

List Price : Rs.970

31 Splines



RDS 6261 A

Differential Coupling Flange
Swaraj Mazda (31 Splines)
(Square Base) (4 Holes)
(Hole Dia 10.1 mm) (Bolt Size 17 No.)
(Total Height 66 mm) (Oil Seal Size 50 mm)

List Price : Rs.750

34 Splines



RDS 6261 B

Centre Joint Flange
Swaraj Mazda (34 Splines)
(Square Base) (4 Holes)
(Hole Dia 10.1 mm) (Bolt Size 17 No.)
(Total Height 56 mm) (Oil Seal Size 47 mm)

Mating Front Teeth RDS 6261 C

List Price : Rs.750

16 Splines



RDS 1755

Centre Joint Flange
Eicher 11.10
(16 Splines) Square Base
(4 Holes) (Hole Dia 13 mm)
(Bolt Size 19 No.) (Total Height 95 mm)

MRP : Rs.1,460

30 Splines



RDS 976

Centre Joint Flange (RSB 620 Series)
Tata 3118 LPK, 3718, 3723, 2523 LPK
(30 Splines) (Plate Size 7" / 180 mm)
(X Serrated - Side Cut) (4 Holes)
(Hole Dia 15 mm) (Bolt Size 22 No.)
(Total Height 118 mm) (Oil Seal Size 75 mm)

Mating Front Teeth RDS

List Price : Rs. 2,690

30 Splines



RDS 977

Centre Joint Flange (RSB 620 Series)
Tata 3118 LPK, 3718, 3723, 2523 LPK N/M
(30 Splines) (Plate Size 7" / 180 mm)
(X Serrated - Diamond Cut) (4 Holes)
(Hole Dia 15 mm) (Bolt Size 22 No.)
(Total Height 100 mm) (Oil Seal Size 85 mm)

Mating Front Teeth RDS

List Price : Rs. 2,620

39 Splines

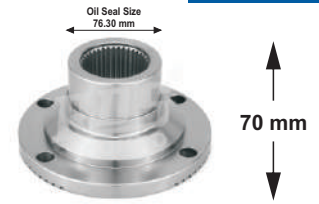

RDS 978

Differential Coupling Flange
Leyland 3723, 2518 (39 Splines)
(Plate Size 6" / 150 mm)
(X Serrated - Round) (4 Holes)
(Hole Dia 13 mm) (Bolt Size 19 No.)
(Total Height 70 mm) (Oil Seal Size 76.30 mm)

List Price : Rs. .1,950

39 Splines



RDS 979

Differential Coupling Flange
Leyland (Meritor MT 1497 Axle) (39 Splines)
(Plate Size 6" / 150 mm)
(X Serrated - Round) (4 Holes)
(Hole Dia 13 mm) (Bolt Size 19 No.)

(Total Height 75 mm) (Oil Seal Size 70 mm)

List Price : Rs. .1,820

39 Splines



RDS 980

Thru Shaft Flange (Inter Axle)
Leyland 2214, 2516, 3118, 2518, 3123
(Compatible with Meritor MT 1495 Axle)
(39 Splines) (Plate Size 6" / 150 mm)
(X Serrated - Round) (4 Holes)
(Hole Dia 13 mm) (Bolt Size 19 No.)

(Total Height 87 mm) (Oil Seal Size 70 mm)

List Price : Rs. .1,860

28 Splines



RDS 461

Centre Joint Flange
Tata 1613 LPT Bus, LPO 1512, LP 1613
(28 Splines) (Plate Size 5.1" / 130 mm)
(Plain Base - Round) (8 Holes)
(Hole Dia 10.2 mm) (Bolt Size 17 No.)
(Total Height 77 mm) (Oil Seal Size 59 mm)

Mating Front Teeth RDS.....

List Price : Rs.1,200

28 Splines



RDS 463

Gear Box Flange (GB 950)
Tata 2523, Leyland 3718 (28 Splines)
(Plate Size 6" / 150 mm)
(X Serrated - Diamond cut) (4 Holes)
(Hole Dia 13 mm) (Bolt Size 19 No.)
(Total Height 60 mm) (Oil Seal Size 72 mm)

List Price : Rs.

*Many
more to
come*

10 Splines



RDS 701

Centre Joint Flange
L/L Taurus 1616 (10 Splines)
(Plate Size 7"/175 mm) (Plain Base)
(8 Holes) (Hole Dia 9.8 mm)
(Bolt Size 15 No.) (Total Height 85 mm)

List Price : Rs.2,095

39 Splines



RDS 702

Differential Coupling Flange
Tata 2518 (39 Splines)
(Plate Size 6"/150 mm) (X Serrated)
(4 Holes) (Hole Dia 13 mm) (Bolt Size 19 No.)
(Total Height 93 mm) (Oil Seal Size 76.30 mm)

List Price : Rs.1,805

39 Splines



RDS 719

Differential Coupling Flange
Leyland 2518 (39 Splines)
(Plate Size 6"/150 mm) (X Serrated)
(4 Holes) (Hole Dia 13 mm) (Bolt Size 19 No.)
(Total Height 93 mm) (Oil Seal Size 71.30 mm)

List Price : Rs.1,805

41 Splines



RDS 703

Differential Coupling Flange
Tata 2518 / Leyland 2516, 2518 (41 Splines)
(Plate Size 6"/150 mm) (X Serrated)
(4 Holes) (Hole Dia 13 mm) (Bolt Size 19 No.)
(Total Height 93 mm) (Oil Seal Size 76.30 mm)

List Price : Rs.1,805

26 Splines



RDS 704

Centre Joint Flange
Tata 2515 / 2516 (RSB Shaft) (26 Splines)
(Plate Size 5"/130 mm) (Plain Base)
(8 Holes) (Hole Dia 10.2 mm)
(Bolt Size 17 No.) (Total Height 92 mm)

List Price : Rs.1,160

28 Splines



RDS 705

Gear Box Flange
Leyland 2516, 3116 (ZF Type) (28 Splines)
(Plate Size 6"/150 mm) (X Serrated)
(4 Holes) (Hole Dia 13 mm)
(Bolt Size 19 No.) (Total Height 100 mm)

List Price : Rs.1,450

34 Splines



RDS 706

Centre Joint Flange
Tata 1616 / 1613 (34 Splines)
(Plate Size 5"/130 mm) (Plain Base)
(8 Holes) (Hole Dia 10.2 mm)
(Bolt Size 17 No.) (Total Height 78 mm)

List Price : Rs.1,240

26 Splines



RDS 708

Gear Box Flange
Tata 2518 / 4018 (GB 75) (26 Splines)
(Plate Size 6"/150 mm) (X Serrated)
(4 Holes) (Hole Dia 13 mm)
(Bolt Size 19 No.) (Total Height 110 mm)

List Price : Rs.2,030

26 Splines



RDS 709

Differential Coupling Flange
Tata 4018 N/M (26 Splines)
(Plate Size 6.5"/165 mm) (Plain Base)
(8 Holes) (Hole Dia 16.2 mm)
(Bolt Size 24 No.) (Total Height 75 mm)

List Price : Rs.1,880

18 Splines



RDS 710

Gear Box Coupling Flange
Tata 4018 N/M (18 Splines)
(Plate Size 6.5"/165 mm) (Plain Base)
(8 Holes) (Hole Dia 16.2 mm)
(Bolt Size 24 No.) (Total Height 75 mm)

List Price : Rs.1,880

34 Splines



RDS 717

Centre Joint Flange
Tata 2518 (34 Splines)
(Plate Size 6"/150 mm) (X Serrated)
(4 Holes) (Hole Dia 13 mm)
(Bolt Size 19 No.) (Total Height 84 mm)

List Price : Rs.1,640

39 Splines



RDS 004

Differential Coupling Flange
Tata 2515 Hywa (39 Splines)
(Plate Size 5"/130 mm) (Plain Base)
(8 Holes) (Hole Dia 10.2 mm)
(Bolt Size 17 No.) (Total Height 87 mm)

List Price : Rs.1,350

41 Splines



RDS 004 A

Differential Coupling Flange
Tata 2515 Hywa (41 Splines)
(Plate Size 5"/130 mm) (Plain Base)
(8 Holes) (Hole Dia 10.2 mm) (Bolt Size 17 No.)
(Total Height 92 mm) (Oil Seal Size 76.30 mm)

List Price : Rs.1,350

18 Splines



RDS 005

Gear Box Flange
Tata 2515 Ex (GB 60) (18 Splines)
(Plate Size 5"/130 mm) (Plain Base)
(8 Holes) (Hole Dia 10.2 mm)
(Bolt Size 17 No.) (Total Height 90 mm)

List Price : Rs.1,210

34 Splines



RDS 006

Centre Joint Flange
Tata 2515 Hywa (34 Splines)
(Plate Size 5"/130 mm) (Plain Base)
(8 Holes) (Hole Dia 10.2 mm)
(Bolt Size 17 No.) (Total Height 78 mm)

List Price : Rs.1,080

26 Splines



RDS 113 A

Differential Coupling Flange
Tata 2518 (26 Splines)
(Plate Size 6"/150 mm) (Plain Base)
(8 Holes) (Hole Dia 12.2 mm)
(Bolt Size 19 No.) (Total Height 67 mm)

List Price : Rs.1,260

18 Splines



RDS 113 C

Gear Box Flange
Tata 2518 (18 Splines)
(Plate Size 6"/150 mm) (Plain Base)
(8 Holes) (Hole Dia 12.2 mm)
(Bolt Size 19 No.) (Total Height 67 mm)

List Price : Rs.1,260

34 Splines



RDS 113 D

Centre Joint Flange
Tata 2518 (34 Splines)
(Plate Size 6"/150 mm) (Plain Base)
(8 Holes) (Hole Dia 12.2 mm)
(Bolt Size 19 No.) (Total Height 75 mm)

List Price : Rs.1,490

26 Splines



RDS 113 E

Differential / Centre Joint Flange
Tata 2518 (26 Splines)
(Plate Size 6"/150 mm) (X Serrated - Diamond Cut)
(4 Holes) (Hole Dia 13 mm)
(Bolt Size 19 No.) (Total Height 62 mm)

List Price Rs. 1,350

26 Splines



RDS 113 E R

Differential / Centre Joint Flange
Tata 2518 (26 Splines)
(Plate Size 6"/150 mm) (X Serrated)
Complete Round (4 Holes) (Hole Dia 13 mm)
(Bolt Size 19 No.) (Total Height 62 mm)

List Price Rs. 1,370

18 Splines



RDS 113 F

Gear Box Flange
Tata 2518 (18 Splines)
(Plate Size 6"/150 mm) (X Serrated)
(4 Holes) (Hole Dia 13 mm)
(Bolt Size 19 No.) (Total Height 62 mm)

List Price : Rs.1,465

34 Splines



RDS 113 G

Centre Joint Flange
Tata 2518 (34 Splines)
(Plate Size 6"/150 mm) (X Serrated)
(4 Holes) (Hole Dia 13 mm)
(Bolt Size 19 No.) (Total Height 62 mm)

List Price : Rs.1,520

26 Splines



RDS 113 H

Differential / Centre Joint Flange
Tata 2515 (26 Splines)
(Plate Size 6"/150 mm) (X Serrated)
(4 Holes) (Hole Dia 13 mm)
(Bolt Size 19 No.) (Total Height 82 mm)

List Price : Rs.1,630

26 Splines



RDS 113 I

Differential / Centre Joint Flange
Tata 2518 (26 Splines)
(Plate Size 6"/150 mm) (X Serrated)
Complete Round (4 Holes) (Hole Dia 13 mm)
(Bolt Size 19 No.) (Total Height 96 mm)

List Price Rs. 1,650

26 Splines



RDS 723

Differential / Centre Joint Flange
Tata 2518 (26 Splines)
(Plate Size 6"/150 mm) (X Serrated - **Diamond Cut**)
(4 Holes) (Hole Dia 13 mm)
(Bolt Size 19 No.) (Total Height 96 mm)

List Price Rs. 1,590

20 Splines



RDS 1751

Centre Joint Flange
Tata 3718 (Without Oil Seal) (20 Splines)
(Plate Size 6"/150 mm) (X Serrated)
(4 Holes) (Hole Dia 13 mm)
(Bolt Size 19 No.) (Total Height 71 mm)

List Price Rs. 1,520

20 Splines



RDS 1752

Centre Joint Flange
Tata 3718 (**Oil Seal Type**) (20 Splines)
(Plate Size 6"/150 mm) (X Serrated)
(4 Holes) (Hole Dia 13 mm) (Bolt Size 19 No.)
(Total Height 71 mm) (Oil Seal Size 63 mm)

List Price Rs. 1,520



26 Splines

RDS 1753

Centre Joint Flange

Tata LPK 2523, 3723 (26 Splines)

(Plate Size 7"/180 mm) (X Serrated - Straight Cut)

(4 Holes) (Hole Dia 15.2 mm)

(Bolt Size 22 No.) (Total Height 96 mm)

List Price : Rs.2,150



26 Splines

RDS 964

Centre Joint Flange

Tata LPK 2523, 3723 (26 Splines)

(Plate Size 7"/180 mm)

(X Serrated - Diamond Cut) (4 Holes)

(Hole Dia 15.2 mm) (Bolt Size 22 No.)

(Total Height 96 mm) **List Price : Rs.2,010**



46 Splines

RDS 1754

Differential Coupling Flange

Tata 4018 / Leyland 2518 (46 Splines)

(Plate Size 6"/150 mm) (X Serrated)

(4 Holes) (Hole Dia 13 mm)

(Bolt Size 19 No.) (Total Height 88 mm)

List Price : Rs.1,880



16 Splines

RDS 1755

Centre Joint Flange

Eicher 11.10

(16 Splines) Square Base

(4 Holes) (Hole Dia 13 mm)

(Bolt Size 19 No.) (Total Height 95 mm)

MRP : Rs.1,460



44 Splines

RDS 1756

Differential Coupling Flange

Tata 4018 / Leyland 2518 (44 Splines)

(Plate Size 6"/150 mm) (X Serrated)

(4 Holes) (Hole Dia 13 mm)

(Bolt Size 19 No.) (Total Height 100 mm)

MRP : Rs.1,830



26 Splines

RDS 1757

Centre Joint Flange

Tata 3128 / Leyland 3136 (Big Bore)

(26 Splines) (Plate Size 6"/150 mm)

(X Serrated) (4 Holes) (Hole Dia 13 mm)

(Bolt Size 19 No.) (Total Height 84 mm)

(Oil Seal Size 90 mm) **MRP : Rs.1,795**



26 Splines

RDS 1758

Centre Joint Flange

Leyland 2214 N / M (26 Splines)

(Plate Size 7"/175 mm) (Plain Base)

(8 Holes) (Hole Dia 9.8 mm)

(Bolt Size 15 No.) (Total Height 98 mm)

List Price : Rs.1,795



34 Splines

RDS 1759

Centre Joint Flange

Tata 2518 (Inter Axle Shaft) (34 Splines)

(Plate Size 6"/150 mm) (X Serrated)

(4 Holes) (Hole Dia 13 mm)

(Bolt Size 19 No.) (Total Height 80 mm)

List Price : Rs.1,860



39 Splines

RDS 1760

Differential Coupling Flange

Leyland 2518 (Inter Axle Shaft)

(39 Splines) (Plate Size 6"/150 mm)

(X Serrated) (4 Holes) (Hole Dia 13 mm)

(Bolt Size 19 No.) (Total Height 85 mm)

(Oil Seal Size 67 mm) **List Price : Rs.1,780**



28 Splines

RDS 1793

Gear Box Flange

Tata 4928 (Eaton Design) (28 Splines)
(Plate Size 6"/150 mm) (X Serrated)
(4 Holes) (Hole Dia 13 mm)
(Bolt Size 19 No.) (Total Height 76 mm)

List Price : Rs.1,980



28 Splines

RDS 951

Gear Box Flange

Leyland 1616 (ZF Design) (28 Splines)
(Square Base) (4 Holes)
(Hole Dia 12.8 mm) (Bolt Size 21 No.)
(Total Height 83 mm) (Oil Seal Size 54 mm)

List Price : Rs.1,420



26 Splines

RDS 952

Gear Box Flange

Tata 2523, 3723, 4023 (GBS 1150)
(Big Bore) (26 Splines) (Plate Size 6"/150 mm)
(X Serrated) (4 Holes) (Hole Dia 13 mm)
(Bolt Size 19 No.) (Total Height 90 mm)
(Oil Seal Size 80 mm) **List Price Rs. 2,060**



26 Splines

RDS 953

Gear Box Flange

Tata 2523, 3723, 4023 (GBS 1150)
(Big Bore) (26 Splines) (Plate Size 7"/180 mm)
(X Serrated) (4 Holes) (Hole Dia 15 mm)
(Bolt Size 22 No.) (Total Height 90 mm)
(Oil Seal Size 80 mm) **List Price : Rs.2,540**



30 Splines

RDS 954

Gear Box Flange

Tata 4928 (Eaton Design) (30 Splines)
(Plate Size 6"/150 mm) (X Serrated)
(4 Holes) (Hole Dia 13 mm)
(Bolt Size 19 No.) (Total Height 76 mm)

List Price : Rs.1,945



30 Splines

RDS 955

Gear Box Flange

Tata 4928 (Eaton Design) (30 Splines)
(Plate Size 7"/180 mm) (X Serrated)
(4 Holes) (Hole Dia 15.2 mm)
(Bolt Size 22 No.) (Total Height 76 mm)

List Price : Rs.2,530



39 Splines

RDS 956

Centre Joint Flange

Tata 3718, 2518 (39 Splines)
(Plate Size 6" / 150 mm)
(X Serrated - Diamond Cut) (4 Holes)
(Hole Dia 13 mm) (Bolt Size 19 No.)
(Total Height 82 mm)

Mating Front Teeth RDS 252

List Price : Rs. 1,590



46 Splines

RDS 957

Centre Joint Flange

Tata 3718, 2518 (46 Splines)
(Plate Size 6" / 150 mm)
(X Serrated - Diamond Cut) (4 Holes)
(Hole Dia 13 mm) (Bolt Size 19 No.)
(Total Height 82 mm)

Mating Front Teeth RDS 251

List Price : Rs. 1,590



20 Splines

RDS 958

Centre Joint Flange

Tata 1624, 1625, 4129 L/L 3518 (20 Splines)
(Plate Size 7"/180 mm) (X Serrated)
(4 Holes) (Hole Dia 15.2 mm)
(Bolt Size 22 No.) (Total Height 71 mm)

List Price : Rs.1,940



46 Splines

RDS 959

Differential Coupling Flange
Tata 4018/ Leyland 2518 (46 Splines)
(Plate Size 7"/180 mm) (X Serrated)
(4 Holes) (Hole Dia 15 mm)
(Bolt Size 22 No.) (Total Height 69 mm)

List Price : Rs.2,560



46 Splines

RDS 960

Differential Coupling Flange
Tata 4018/ Leyland 2518 (46 Splines)
(Plate Size 7"/180 mm) (X Serrated)
(4 Holes) (Hole Dia 15 mm)
(Bolt Size 22 No.) (Total Height 90 mm)

List Price : Rs.2,560



32 Splines

RDS 961

Gear Box Flange
Eicher Terra 16 (32 Splines)
(Plate Size 6"/150 mm) (X Serrated)
(4 Holes) (Hole Dia 13 mm)
(Bolt Size 19 No.) (Total Height 90 mm)

List Price : Rs.1,915



34 Splines

RDS 962

Centre Joint Flange
Tata 407/ LPO (34 Splines)
(Plate Size 5"/120 mm) (X Serrated)
(4 Holes) (Hole Dia 11.2 mm)
(Bolt Size 18 No.) (Total Height 60 mm)

List Price : Rs.1,220



10 Splines

RDS 963

Centre Joint Flange
Tata 909 / 1109 (10 Splines)
(Plate Size 5"/120 mm) (X Serrated)
(4 Holes) (Hole Dia 11.2 mm)
(Bolt Size 18 No.) (Total Height 60 mm)

List Price : Rs.1,220



10 Splines

RDS 6132

Differential / Pinion Coupling Flange
Leyland 370 (10 Splines)
(Plate Size 6"/146 mm, Plain Base)
(4 Holes) (Hole Dia 12.8 mm)
(Bolt Size 21 No.) (Total Height 85 mm)

List Price : Rs.1,345



RDS 6133

Centre Joint Flange
Leyland 370 (Key Type)
(Square Base)
(4 Holes) (Hole Dia 12.8 mm)
(Bolt Size 21 No.) (Total Height 73 mm)

List Price : Rs.1,170



6 Splines

RDS 6134

Gear Box Flange
Leyland 370 / Taskar (6 Splines)
(Square Base)
(4 Holes) (Hole Dia 12.8 mm)
(Bolt Size 21 No.) (Total Height 98 mm)

List Price : Rs.995



6 Splines

RDS 6134 A

Gear Box Flange
Leyland 370 / Taskar (6 Splines) (Plain Base)
(Plate Size 6" / 146 mm, Round Base)
(4 Holes) (Hole Dia 12.8 mm)
(Bolt Size 21 No.) (Total Height 98 mm)

List Price : Rs.1,470

10 Splines



RDS 6148

Centre Joint Flange
Leyland Taskar (10 Splines)
(Square Base)
(4 Holes) (Hole Dia 12.8 mm)
(Bolt Size 21 No.) (Total Height 73 mm)
List Price : Rs.1,170

34 Splines



RDS 6231 I

Centre Joint Flange
Leyland 2516 / 2214, Eicher 30.15, 30.25
(34 Splines) (Plate Size 7"/175 mm Plain Base)
(8 Holes) (Hole Dia 9.8 mm)
(Bolt Size 15 No.) (Total Height 61 mm)
List Price : Rs.1,480

28 Splines



RDS 6237 A

Gear Box Flange
Leyland 2516 / 2214 (28 Splines)
(Plate Size 7"/175 mm, Plain Base)
(8 Holes) (Hole Dia 9.8 mm)
(Bolt Size 15 No.) (Total Height 61 mm)
List Price: Rs.1,480

39 Splines



RDS 6231 J

Differential / Pinion Coupling Flange
Leyland 2516 / 2214 (39 Splines)
(Plate Size 7"/175 mm, Plain Base)
(8 Holes) (Hole Dia 9.8 mm)
(Bolt Size 15 No.) (Total Height 88 mm)
(Oil Seal Size 76.30 mm) **List Price : Rs.2,020**

39 Splines



RDS 722

Differential / Pinion Coupling Flange
Leyland 2516 / 2214 (39 Splines)
(Plate Size 7"/175 mm, Plain Base)
(8 Holes) (Hole Dia 9.8 mm)
(Bolt Size 15 No.) (Total Height 88 mm)
(Oil Seal Size 71.30 mm) **List Price : Rs.2,020**

41 Splines



RDS 6231 K

Differential / Pinion Coupling Flange
Leyland 2516 / 2214 (41 Splines)
(Plate Size 7"/175 mm, Plain Base)
(8 Holes) (Hole Dia 9.8 mm)
(Bolt Size 15 No.) (Total Height 90 mm)
(Oil Seal Size 76.30 mm) **List Price: Rs.2,020**

34 Splines



RDS 6239

Output Shaft Flange
Leyland 2516 / 2214 (34 Splines)
(Square Base)
(4 Holes) (Hole Dia 12.8 mm)
(Bolt Size 21 No.) (Total Height 78 mm)
(Oil Seal Size 63.5 mm) **List Price : Rs.1,082**

39 Splines



RDS 6240

Output Shaft Flange
Leyland 2516 / 2214 (39 Splines)
(Square Base)
(4 Holes) (Hole Dia 12.8 mm)
(Bolt Size 21 No.) (Total Height 88 mm)
(Oil Seal Size 76.30 mm) **List Price : Rs.1,230**

41 Splines



RDS 6241

Output Shaft Flange
Leyland 2516 / 2214 (41 Splines)
(Square Base)
(4 Holes) (Hole Dia 12.8 mm)
(Bolt Size 21 No.) (Total Height 88 mm)
(Oil Seal Size 76.30 mm) **List Price : Rs.1,230**

10 Splines



RDS 153

Centre Joint Flange
Leyland 1613 Turbo / E Comet (10 Splines)
(Plate Size 6" / 146 mm, Plain Base)
(4 Holes) (Hole Dia 12.8 mm)
(Bolt Size 21 No.) (Total Height 63 mm)

List Price : Rs.1,235

39 Splines



RDS 154

Differential / Pinion Coupling Flange
Leyland 1613 Turbo / E Comet (39 Splines)
(Plate Size 6" / 146 mm, Plain Base)
(4 Holes) (Hole Dia 12.8 mm)
(Bolt Size 21 No.) (Total Height 86 mm)

List Price : Rs.1,235

16 Splines



RDS 6228

Centre Joint Flange
Leyland Taurus 1616 / Eicher 30.25
(16 Splines) (Plate Size 7"/175 mm, Plain Base)
(8 Holes) (Hole Dia 9.8 mm)
(Bolt Size 15 No.) (Total Height 95 mm)

List Price : Rs.2,095

28 Splines



RDS 6246

Gear box Flange (Bell Type)
Leyland 2516 / 2516 (28 Splines)
(Plate Size 7"/175 mm, Plain Base)
(8 Holes) (Hole Dia 9.8 mm)
(Bolt Size 15 No.) (Total Height 115 mm)

List Price : Rs.1,995

28 Splines



RDS 965

Centre Joint Flange Tata 4923
(28 Splines) (Plate Size 6"/150 mm)
(X Serrated - Diamond Cut)
(4 Holes) (Hole Dia 13 mm)
(Bolt Size 19 No.) (Total Height 78 mm)

List Price : Rs.

10 Splines



RDS 6229

Differential Coupling Flange
Leyland Taurus (10 Splines)
(Plate Size 7"/175 mm, Plain Base)
(8 Holes) (Hole Dia 9.8 mm)
(Bolt Size 15 No.) (Total Height 92 mm)

List Price: Rs.1,820

41 Splines



RDS 966

Differential Coupling Flange
Tata 4018 (Long), AMW 2515/2516/2518
(41 Splines) (Plate Size 6.5"/165 mm)
(Plain Base) (8 Holes) (Hole Dia 16.2 mm)
(Bolt Size 24 No.) (Total Height 110 mm)

List Price : Rs.2,450

39 Splines



RDS 968

Differential Coupling Flange
Tata 4018 (Long), AMW 2515/2516/2518
(39 Splines) (Plate Size 6.5"/165 mm)
(Plain Base) (8 Holes) (Hole Dia 16.2 mm)
(Bolt Size 24 No.) (Total Height 110 mm)
(Oil Seal Size 71.30 mm) **List Price : Rs.**

26 Splines



RDS 969

Differential Coupling Flange
Tata 3118, 3128 / Leyland 3136 (Big Bore)
(26 Splines) (Plate Size 7"/180 mm)
(X Serrated) (4 Holes) (Hole Dia 12.8 mm)
(Bolt Size 21 No.) (Total Height 63 mm)
(Oil Seal Size 90 mm) **List Price : Rs.**



39 Splines

RDS 971

Differential Coupling Flange
Tata 2515 Hywa (39 Splines)
(Plate Size 5"/130 mm) (Plain Base)
(8 Holes) (Hole Dia 10.2 mm) (Bolt Size 17 No.)
(Total Height 87 mm) (Oil Seal Size 71.30 mm)

List Price : Rs.1,350



46 Splines

RDS 972

Differential Coupling Flange
Tata 4018 / Leyland 2518 (46 Splines)
(Plate Size 6"/150 mm) (X Serrated)
(4 Holes) (Hole Dia 13 mm)
(Bolt Size 19 No.) (Total Height 92 mm)
(Oil Seal Size 85 mm) **List Price : Rs.1,960**



26 Splines

RDS 973

Gear Box Flange
Tata 4923, Prima (GB - 75) (26 Splines)
(Plate Size 7"/180 mm - X Serrated)
(4 Holes) (Hole Dia 15.2 mm)
(Bolt Size 22 No.) (Total Height 110 mm)

List Price : Rs.2,520



16 Splines

RDS 974

Differential Coupling Flange
Eicher Terra 16 (16 Splines)
(Plate Size 6"/150 mm) (X Serrated)
(4 Holes) (Hole Dia 13 mm)
(Bolt Size 19 No.) (Total Height 96 mm)
(Oil Seal Size 71.30 mm) **List Price : Rs.2,230**



.....

RDS 975

.....Flange
Tata.....(.....Splines)
(Plate Size 7"/180 mm - X Serrated)
(4 Holes) (Hole Dia 15.2 mm)
(Bolt Size 22 No.) (Total Heightmm)
List Price : Rs.....



28 Splines

RDS 463

Gear Box Flange GB 950
Tata 2523, Leyland 3718 (28 Splines)
(Plate Size 6" / 150 mm)
(X Serrated - Diamond Cut) (4 Holes)
(Hole Dia 13 mm) (Bolt Size 19 No.)

(Total Height 60 mm) (Oil Seal Size 72 mm)

List Price Rs.1,650 Each



26 Splines

RDS 464

Centre Joint Flange (SPR 2060 Series)
Tata LPK 3128, 3138 (26 Splines)
(Plate Size 7" / 180 mm, X Serrated)
(4 Holes) (Hole Dia 15.2 mm) (Bolt Size 22 No.)

(Total Height 96 mm) (Oil Seal Size 79.5 mm)

List Price Rs.2,870 Each

LONG FORK YOKE (With Dust Cover)

30 Teeth



13"
330 mm

RDS 148 M

Tata 4018 / 3118 (Short)
RSB 490 Series (30 Teeth)
Total Length 13" / 330 mm
Mating Bottle : RDS 148 A

U J Cross Fitting : RDS 111 / 111 GL

(48 mm x 135 mm) **List Price : Rs.4,310**

30 Teeth



14.5"
368 mm

RDS 150

Tata 4018 / 3118 (Medium)
RSB 490 Series (30 Teeth)
Total Length 14.5" / 368 mm
Mating Bottle : RDS 150 A / 150 B / 651 / 656

U J Cross Fitting : RDS 111 / 111 GL

(48 mm x 135 mm) **List Price : Rs.4,540**

30 Teeth



16"
400 mm

RDS 1781

Tata 4018 / 3118 (Long)
RSB 490 Series (30 Teeth)
Total Length 16" / 400 mm
Mating Bottle : RDS 1782

U J Cross Fitting : RDS 111 / 111 GL

(48 mm x 135 mm) **List Price : Rs.5,300**

16 Teeth



14.5"
368 mm

RDS 1901

Tata 2518 LPT, 4018, Leyland 3116

MSL Design (16 Teeth)

Total Length 14.5" / 368 mm

Mating Bottle : RDS 1912

U J Cross Fitting : RDS 111 / 111 GL

(48 mm x 135 mm) **List Price : Rs.4,650**

20 Teeth



12.5"
315 mm

RDS 112 D

Tata 2515 Ex (Short)
RSB 325 Series (20 Teeth)
Total Length 12.5" / 315 mm

Mating Bottle : RDS 194 B

U J Cross Fitting : RDS 117

(42 mm x 119 mm) **List Price : Rs.3,740**

20 Teeth



13"
335 mm

RDS 194 M

Tata 2515 / 2518 (Short)
RSB 403 Series (20 Teeth)
Total Length 13" / 335 mm

Mating Bottle : RDS 194 A

U J Cross Fitting : RDS 121 M

(42 mm x 129.35 mm) **List Price : Rs.3,800**

LONG FORK YOKE (With Dust Cover)

20 Teeth



14.5"
368 mm

RDS 198

Tata 2515 / 2518 (Medium)

RSB 403 Series (20 Teeth)

Total Length 14.5" / 368 mm

Mating Bottle : RDS 195 A / RDS 196

U J Cross Fitting : RDS 121 M

(42 mm x 129.35 mm) **List Price : Rs.4,860**

20 Teeth



16"
400 mm

RDS 195 M

Tata 2515 / 2518 (Long)

RSB 403 Series (20 Teeth)

Total Length 16" / 400 mm

Mating Bottle : RDS 195 A / RDS 196

U J Cross Fitting : RDS 121 M

(42 mm x 129.35 mm) **List Price : Rs.4,860**

34 Teeth



13"
330 mm

RDS 1708

Tata 4928, 2528, 3128, Bharat Benz 2523,

SPICER 2040 Series (Short)

(34 Teeth) Total Length 13" / 330 mm

Mating Bottle : RDS 1705 / RDS 1788 / RDS 1789

RDS 652 / RDS 653 / RDS 654 / RDS 655

U J Cross Fitting : RDS 6202 G / RDS 907 GL

(47.65 mm x 135 mm) **List Price : Rs. 4250**

34 Teeth



14"
356 mm

RDS 1709

Tata 4928, 2528, 3128, Bharat Benz 2523,

SPICER 2040 Series (MEDIUM)

(34 Teeth) Total Length 14" / 356 mm

Mating Bottle : RDS 1705 / RDS 1788 / RDS 1789 /

RDS 652 / RDS 653 / RDS 654 / RDS 655

U J Cross Fitting : RDS 6202 G / RDS 907 GL

(47.65 mm x 135 mm) **List Price : Rs.4,940**

34 Teeth



15"
380 mm

RDS 1704

Tata 4928, 2528, 3128, Bharat Benz 2523,

SPICER 2040 Series (LONG)

(34 Teeth) Total Length 15" / 380 mm

Mating Bottle : RDS 1705 / 652 / 653 / 654 / 655

U J Cross Fitting : RDS 6202 G / RDS 907 GL

(47.65 mm x 135 mm) **List Price : Rs.4,940**

16 Teeth



15.5"
390 mm

RDS 1902

Tata 4928, 2528, 3128, Bharat Benz 2523,

MSL 2040 Series (16 Teeth)

Total Length 15.5" / 390 mm

Mating Bottle : RDS 1913

U J Cross Fitting : RDS 6202 G / RDS 907 GL

(47.65 mm x 135 mm) **List Price : Rs.5,140**

36 Teeth



14.5"
368 mm

RDS 1733

Tata 3723, 4027,
SPICER 2045, 2047 / RSB 590 Series (36 Teeth)
Total Length 14.5" / 368 mm
Mating Bottle : RDS 1734
U J Cross Fitting : RDS 218 / RDS 218 GL
(52 mm x 147 mm) List Price : Rs.6,580

38 Teeth



14"
355 mm

RDS 1739

Tata 4028, Leyland 3123 (SHORT)
Bharat Benz 2523, Eicher HCV
RSB 590, SPR 2045 / 2047 Series (38 Teeth)
Total Length 14" / 355 mm
Mating Bottle : RDS 1790
U J Cross Fitting : RDS 218 / 218 GL
(52 mm x 147 mm) List Price : Rs.6,410

38 Teeth



15"
380 mm

RDS 1738

Tata 4028, Leyland 3123 (MEDIUM)
Bharat Benz 2523, Eicher HCV
RSB 590, SPR 2045 / 2047 Series (38 Teeth)
Total Length 15" / 380 mm
Mating Bottle : RDS 1790
U J Cross Fitting : RDS 218 / 218 GL
(52 mm x 147 mm) List Price : Rs.6,410

38 Teeth



16"
400 mm

RDS 1785

Tata 4028, Leyland 3123 (LONG)
Bharat Benz 2523, Eicher HCV
RSB 590, SPR 2045 / 2047 Series (38 Teeth)
Total Length 16" / 400 mm Mating Bottle : RDS 1790
U J Cross Fitting : RDS 218 / 218 GL
(52 mm x 147 mm) List Price : Rs.6,410

30 Teeth



13"
330 mm

RDS 1783

Tata 3723, 4027 (Short)
RSB 590, SPR 2045 / 2047 Series (30 Teeth)
Total Length 13" / 330 mm
Mating Bottle : RDS 1786, 1787, 150 A, 150 B
U J Cross Fitting : RDS 218 / 218 GL
(52 mm x 147 mm) List Price : Rs.5,555

30 Teeth



14"
355 mm

RDS 1784

Tata 3723, 4027 (Medium)
RSB 590, SPR 2045 / 2047 Series (30 Teeth)
Total Length 14" / 355 mm
Mating Bottle : RDS 1786, 1787, 150 A, 150 B
U J Cross Fitting : RDS 218 / 218 GL
(52 mm x 147 mm) List Price : Rs.5,555

30 Teeth



RDS 1794

Tata 3723, 4027 (LONG)
RSB 590, SPR 2045 / 2047 Series (30 Teeth)

Total Length 14.5" / 368 mm

Mating Bottle : RDS 1786, 1787, 150 A & 1782
U J Cross Fitting : RDS 218 / 218 GL

(52 mm x 147 mm) List Price : Rs.6,200

30 Teeth



RDS 1796

Tata 3723, 4027, 2630 (EXTRA LONG)
RSB 590, SPR 2045 / 2047 Series (30 Teeth)

Total Length 16" / 400 mm

Mating Bottle : RDS 1786, 1787, 150 A & 1782
U J Cross Fitting : RDS 218 / 218 GL

(52 mm x 147 mm) List Price : Rs.6,200

36 Teeth



RDS 1723

Tata 1828, 2138 Leyland 3123, Eicher 40 T
RSB 620, SPR 2055 Series (36 Teeth)

Total Length 14.5" / 368 mm

Mating Bottle : RDS 1734
U J Cross Fitting : RDS 219

(57 mm x 152 mm) List Price : Rs.6,580

20 Teeth



RDS 1903

Tata 2528, Leyland 4928 (Short)
SPL 90 Series (20 Teeth)

Total Length 12.5" / 320 mm

Mating Bottle : RDS 194 A
U J Cross Fitting RDS 6202 H

(41.28 mm x 126 mm)
List Price : Rs.4,760

20 Teeth



RDS 1904

Tata 2528, Leyland 4928 (Long)
SPL 90 Series (20 Teeth)

Total Length 13.5" / 340 mm

Mating Bottle : RDS 194 A
U J Cross Fitting RDS 6202 H

(41.28 mm x 126 mm)
List Price : Rs.4,760

36 Teeth



RDS 1905

Tata 3723, 4027, 2630
RSB 590 Series (36 Teeth)

Total Length 16" / 400 mm

Mating Bottle : RDS 1734 / RDS 1916
U J Cross Fitting RDS 218 / 218 GL

(52 mm x 147 mm)
List Price : Rs.6,510

LONG FORK YOKE (With Dust Cover)

38 Teeth



12.5"
320 mm

RDS 1906

Tata 4923, AMW 3123
 SPR 2045 / 2047 Series (38 Teeth)
 Total Length 12.5" / 320 mm
 Mating Bottle : RDS 1915
 U J Cross Fitting RDS 218 / 218 GL
 (52 mm x 147 mm)
 List Price : Rs.5,400

20 Teeth



15.75"
400 mm

RDS 1907

Tata 2516, 2515 Long
 RSB 325 Series (20 Teeth)
 Total Length 15.75" / 400 mm
 Mating Bottle : RDS 195 A
 U J Cross Fitting RDS 117
 (42 mm x 119 mm)
 List Price : Rs.....

16 Teeth



14.25"
362 mm

RDS WP 3110

Long Yoke AMW 2518 (Inter Axle Shaft)
 (16 Teeth) Total Length 14.25" / 362 mm
 1 Pc. H/Yoke RDS 1772 & 1 Pc. R/Teeth RDS 142
 U J Cross Fitting RDS 6202 H (SPL 90 Series)
 (41.28 mm x 126 mm)
 List Price : Rs.5,200

16 Teeth



14.75"
375 mm

RDS WP 3111

Long Yoke AMW 2518 (Inter Axle Shaft)
 (16 Teeth) Total Length 14.75" / 375 mm
 1 Pc. H/Yoke RDS 1772 & 1 Pc. R/Teeth RDS 142
 U J Cross Fitting RDS 6202 H (SPL 90 Series)
 (41.28 mm x 126 mm)
 List Price : Rs.5,200

*Many more
to come*

30 Splines



8"
200 mm

RDS 148 A

Tata 4018 / 3118

(RSB 490 Series Short) (30 Splines)

Head Size : 4" / 95 mm, Total Length : 8" / 200 mm

Mating Long Fork : RDS 148 M

List Price : Rs.2,580

30 Splines



8"
200 mm

RDS 657

Tata 4018 / 3118 (RSB 490 Series Short)

(30 Splines) **(TEFLON COATED)**

Head Size : 4" / 95 mm, Total Length : 8" / 200 mm

Mating Long Fork : RDS 148 M

List Price : Rs.3,170

30 Splines



9"
225 mm

RDS 150 B

Tata 4018 / 3118

(RSB 490 Series Medium) (30 Splines)

Head Size : 4" / 95 mm, Total Length : 9" / 225 mm

Mating Long Fork : RDS 150

List Price : Rs.2,800

30 Splines



9"
225 mm

RDS 651

Tata 4018 / 3118 RSB 490 Series (Medium)

(30 Splines) **(TEFLON COATED)**

Head Size : 4" / 95 mm, Total Length : 9" / 225 mm

Mating Long Fork : RDS 150

List Price : Rs.3,370

30 Splines



10"
256 mm

RDS 150 A

Tata 4018 / 3118

(RSB 490 Series Long) (30 Splines)

Head Size : 4" / 95 mm, Total Length : 10" / 256 mm

Mating Long Fork : RDS 150

List Price : Rs.2,870

30 Splines



10"
256 mm

RDS 656

Tata 4018 / 3118 RSB 490 Series (Long)

(30 Splines) **(TEFLON COATED)**

Head Size : 4" / 95 mm, Total Length : 10" / 256 mm

Mating Long Fork : RDS 150

List Price : Rs.3,480

30 Splines



10.5"
265 mm

RDS 1782

Tata 4018 / 3118 (RSB 490 Extra Long)
(30 Splines) Head Size : 4" / 95 mm,
Total Length : 10.5" / 265 mm
Mating Long Fork : RDS 1781
List Price : Rs.3,210

30 Splines



10.5"
265 mm

RDS 658

Tata 4018 / 3118 (RSB 490 Series Extra Long)
(30 Splines) **(TEFLON COATED)**
Head Size : 4" / 95 mm, Total Length : 10.5" / 265 mm
Mating Long Fork : RDS 1781
List Price : Rs.3,710

34 Splines



8.5"
220 mm

RDS 1788

Tata 4928, Bharat Benz 2523
(SPR 2040 Series Short) (34 Splines)
Head Size : 4" / 91.5 mm, Total Length : 8.5" / 220 mm
Mating Long Fork : RDS 1704 / RDS 1708 / RDS 1709
List Price : Rs.2,840

34 Splines



9"
225 mm

RDS 1911

Tata 4928 / 2528, Bharat Benz 2523, 2528
(SPR 2040 Series Medium) (34 Splines)
Head Size : 4" / 91.5 mm, Total Length : 9" / 225 mm
Mating Long Fork : RDS 1704 / RDS 1708 / RDS 1709
List Price : Rs.2,800

34 Splines



9"
225 mm

RDS 652

Tata 4928 / 2528, Bharat Benz 2523 / 2528
SPR 2040 Series (Medium) (34 Splines)
(TEFLON COATED) Head Size : 4" / 91.5 mm
Total Length : 9" / 225 mm Mating Long Fork : RDS 1704
List Price : Rs.3,210

34 Splines



9.5"
240 mm

RDS 1789

Tata 4928, Bharat Benz 2523
(SPR 2040 Series Medium) (34 Splines)
Head Size : 4" / 91.5 mm, Total Length : 9.5" / 240 mm
Mating Long Fork : RDS 1704, RDS 1708, RDS 1709
List Price : Rs.3,010

34 Splines



RDS 1705

Tata 4928, Bharat Benz 2523
 (SPR 2040 Series Long) (34 Splines)
 Head Size : 4" / 91.5 mm, Total Length : 10.5" / 265 mm
 Mating Long Fork : RDS 1704
List Price : Rs.3,210

34 Splines



RDS 654

Tata 4928, Bharat Benz 2523
 (SPR 2040 Series Long) 34 Splines **(TEFLON COATED)**
 Head Size : 4" / 91.5 mm, Total Length : 10.5" / 265 mm
 Mating Long Fork : RDS 1704
List Price : Rs.3,820

34 Splines



RDS 653

Tata 4928 / 4028, Bharat Benz 2523 / 2528
CAVITY TYPE (TEFLON COATED) SPR 2040 Series (34 Splines)
 Head Size : 4" / 91.5 mm Total Length : 8.5" / 220 mm
 Mating Long Fork : RDS 1704 / 1708 / 1709
List Price : Rs.3,240

34 Splines



RDS 655

Tata 4928 / 4028, Bharat Benz 2523 / 2528
CAVITY TYPE (TEFLON COATED) SPR 2040 Series (34 Splines)
 Head Size : 4" / 91.5 mm, Total Length : 9.5" / 240 mm
 Mating Long Fork : RDS 1704 / 1708 / 1709
List Price : Rs.3,370

36 Splines



RDS 1734

Tata 4928, 4028, 3128
 (RSB 590 Series Short) (36 Splines)
 Head Size : 4.5" / 112 mm, Total Length : 8.3" / 210 mm
 Mating Long Fork : RDS 1733
List Price : Rs.3,690

36 Splines



RDS 1916

Tata 4928,4028,3128 (RSB 590 Series Short)
 (36 Splines) **(TEFLON COATED)**
 Head Size : 4.5" / 112 mm, Total Length : 8.3" / 210 mm
 Mating Long Fork : RDS 1733
List Price : Rs.4,300



10"
256 mm

RDS 1790

Tata 3723 / 4027

(SPR 2045 / 2047 Series)

(38 Splines) **(TEFLON COATED)**

Head Size : 4" / 100 mm, Total Length : 10" / 256 mm

Mating Long Fork : RDS 1785, RDS 1738, RDS 1739

List Price : Rs.4,350



10"
256 mm

38 Splines

RDS 1792

Tata 3723, 4027

CAVITY TYPE (TEFLON COATED)

SPR 2045 / 2047 Series (38 Splines)

Head Size : 4" / 100 mm Total Length : 10" / 256 mm

Mating Long Fork : RDS 1738, RDS 1739, RDS 1785

List Price : Rs.4,230



11"
280 mm

38 Splines

RDS 1914

Tata 3723,4027,2630 (SPR 2045 / 2047 Series Long)

(38 Splines) **(TEFLON COATED)**

Head Size : 4" / 100 mm, Total Length : 11" / 280 mm

Mating Long Fork : RDS 1785

List Price : Rs.....



8"
200 mm

38 Splines

RDS 1915

Tata 3723,4027,2630 (SPR 2045 / 2047 Series Short)

(38 Splines) **(TEFLON COATED)**

Head Size : 4.5" / 112 mm, Total Length : 8" / 200 mm

Mating Long Fork : RDS 1906

List Price : Rs.3,810



8"
200 mm

30 Splines

RDS 1786

Tata 4028, 3128, Eicher

CAVITY TYPE (TEFLON COATED)

RSB 590 Series (30 Splines)

Head Size : 4" / 95 mm Total Length : 8" / 200 mm

Mating Long Fork : RDS 150, RDS 1783, RDS 1784

List Price : Rs.3,100



9"
225 mm

30 Splines

RDS 1787

Tata 4028, 3128, Eicher

CAVITY TYPE (TEFLON COATED)

RSB 590 Series (30 Splines)

Head Size : 4" / 95 mm Total Length : 9" / 225 mm

Mating Long Fork : RDS 150, RDS 1783, RDS 1784

List Price : Rs.3,130

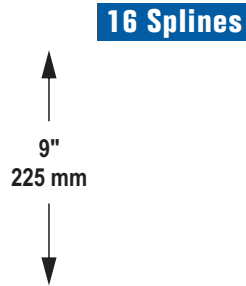

16 Splines

RDS 1912

Tata 2518 LPT, Leyland 3116 (16 Splines)
MSL Design (TEFLON COATED)
Head Size : 4" / 95 mm, Total Length : 9" / 225 mm
Mating Long Fork : RDS 1901
List Price : Rs.3,630

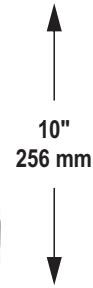

16 Splines

RDS 1913

Tata 4928, Bharat Benz 2523 C (16 Splines)
(MSL 2040 Design) (TEFLON COATED)
Head Size : 4" / 95 mm, Total Length : 10" / 256 mm
Mating Long Fork : RDS 1902
List Price : Rs.3,740



20 Splines

RDS 196

Tata 2515 / 2518
(RSB 403 Series Long) (20 Splines)
Head Size : 4" / 95 mm (Total Length : 10.5" / 265 mm)
Mating Long Fork : RDS 195 M / RDS 198
List Price : Rs.2,980

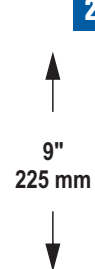

20 Splines

RDS 195 A

Tata 2515 / 2518 (RSB 403 Series Medium)
(20 Splines) Head Size : 4" / 95 mm
Total Length : 9" / 225 mm
Mating Long Fork : RDS 195 M / RDS 198
List Price : Rs.2,630

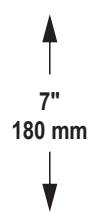

20 Splines

RDS 194 A

Tata 2515 / 2518 (RSB 403 Series Short)
(20 Splines) Head Size : 4" / 95 mm
Total Length : 7" / 180 mm
Mating Long Fork : RDS 194 M
List Price : Rs.2,325



20 Splines

RDS 194 B

Tata 2515 Ex (RSB 325 Series)
(20 Splines) Head Size : 3.5" / 84 mm
Total Length : 6.7" / 170 mm
Mating Long Fork : RDS 112 D
List Price : Rs.2,120

RSB 325 Series (20 Teeth)



RDS 553
(RDS 112 D & RDS 194 A)
 Long Fork & Bottle Set Tata 2515 EX (Short)
 RSB 325 Series (20 Teeth)
 Cross Fitting RDS 117 (42 mm x 119 mm)
List Price Rs.6,065

RSB 325 Series (20 Teeth)



RDS 554
(RDS 112 D & RDS 194 B)
 Long Fork & Bottle Set Tata 2515 EX
 RSB 325 Series (20 Teeth)
 Cross Fitting RDS 117 (42 mm x 119 mm)
List Price Rs.5,860

RSB 490 Series (30 Teeth)



RDS 556
(RDS 148 M & RDS 148 A)
 Long Fork & Bottle Set Tata 4018 / 3118
 RSB 490 Series (Small) (30 Teeth)
 Cross Fitting RDS 111 / 111 GL (48 mm x 135 mm)
List Price Rs.6,890

RSB 490 Series (30 Teeth)



RDS 577
(RDS 148 M & RDS 657)
 Long Fork & Bottle Set Tata 4018 / 3118
 RSB 490 Series (Small) (30 Teeth) **TEFLON COATED**
 Cross Fitting RDS 111 / 111 GL (48 mm x 135 mm)
List Price Rs.7,520

RSB 490 Series (30 Teeth)



RDS 555

(RDS 150 & RDS 150 A)

Long Fork & Bottle Set Tata 4018 / 3118

RSB 490 Series (Medium) (30 Teeth)

Cross Fitting RDS 111 / 111 GL (48 mm x 135 mm)

List Price Rs.7,400

RSB 490 Series (30 Teeth)



RDS 583

(RDS 150 & RDS 656)

Long Fork & Bottle Set Tata 4018 / 3118

RSB 490 Series (Medium) (30 Teeth) **TEFLON COATED**

Cross Fitting RDS 111 / 111 GL (48 mm x 135 mm)

List Price Rs.8,000

RSB 490 Series (30 Teeth)

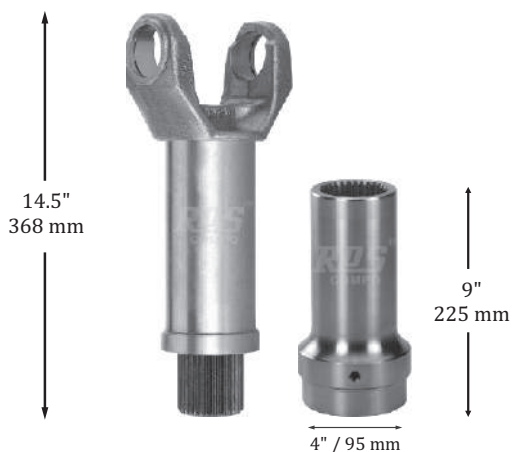

RDS.....

(RDS 150 & RDS 150 B)

Long Fork & Bottle Set Tata 4018 / 3118

RSB 490 Series (Medium) (30 Teeth)

Cross Fitting RDS 111 / 111 GL (48 mm x 135 mm)

List Price Rs.....

RSB 490 Series (30 Teeth)



RDS 570

(RDS 150 & RDS 651)

Long Fork & Bottle Set Tata 4018 / 3118

RSB 490 Series (Medium) (30 Teeth) **TEFLON COATED**

Cross Fitting RDS 111 / 111 GL (48 mm x 135 mm)

List Price Rs.7,900

RSB 490 Series (30 Teeth)



RDS 578

(RDS 1781 & RDS 658)

Long Fork & Bottle Set Tata 4018 / 3118

RSB 490 Series (Long) (30 Teeth) **TEFLON COATED**

Cross Fitting RDS 111 / 111 GL (48 mm x 135 mm)

List Price Rs.9,010

SPR 2040 Series (34 Teeth)



RDS 584

(RDS 1704 & RDS 655)

Long Fork & Bottle Set Tata 4928, 2528, 3128

SPR 2040 Series (LONG) (34 Teeth)

Cross Fitting RDS 6202 G / 907 GL (47.65 mm x 135 mm)

List Price Rs.....

SPR 2040 Series (34 Teeth)



RDS 1706

Long Fork & Bottle Set Tata 4928, 2528, 3128

SPR 2040 Series (LONG) (34 Teeth)

Cross Fitting RDS 6202 G / 907 GL (47.65 mm x 135 mm)

(Ref. RDS 1704 & RDS 1705)

List Price Rs.....

SPR 2040 Series (34 Teeth)



RDS 569

Long Fork & Bottle Set Tata 4928, 2528, 3128

SPR 2040 Series (LONG) (34 Teeth) **Teflon Coated**

Cross Fitting RDS 6202 G / 907 GL (47.65 mm x 135 mm)

(Ref. RDS 1704 & RDS 654)

List Price Rs.....

WELCH PLUGS (Half Yoke & Rear Housing Assembly)

20 Splines



RDS WP 3101

20 Splines (Total Length 14" / 350 mm)
 U J Cross Fitting : RSB 403 Series
 RDS 121 M (42 mm x 129.35 mm)
 Application : AMW 2518 (Inter Axle Shaft)
List Price: Rs.5,370

20 Splines



RDS WP 3106

20 Splines (Total Length 15.5" / 390 mm)
 U J Cross Fitting : RSB 403 Series
 RDS 121 M (42 mm x 129.35 mm)
 Application : AMW 2518 (Inter Axle Shaft)
List Price : Rs.5,070

34 Splines



RDS WP 3102

34 Splines (Total Length 13.75" / 350 mm)
 U J Cross Fitting : SPR 2040 Series
 RDS 6202 G / 907 GL (47.65 mm x 135 mm)
 Application : Tata 3118 (Inter Axle Shaft)
List Price : Rs.5,700

34 Splines



RDS WP 3112
TEFLON COATED

34 Splines (Total Length 13.75" / 350 mm)
 U. J. Cross Fitting : SPR 2040 Series
 RDS 6202 G / 907 GL (47.65 mm x 135 mm)
 Application : Tata 3118 (Inter Axle Shaft)
List Price : Rs.

34 Splines



RDS WP 3103

34 Splines (Total Length 14.75" / 375 mm)
 U J Cross Fitting : SPR 2040 Series
 RDS 6202 G / 907 GL (47.65 mm x 135 mm)
 Application : Tata 3118 (Inter Axle Shaft)
List Price : Rs.5,350

34 Splines



RDS WP 3113
TEFLON COATED

34 Splines (Total Length 14.75" / 375 mm)
 U. J. Cross Fitting : SPR 2040 Series
 RDS 6202 G / 907 GL (47.65 mm x 135 mm)
 Application : Tata 3118 (Inter Axle Shaft)
List Price : Rs.

WELCH PLUGS (Half Yoke & Rear Housing Assembly)

30 Splines

↑
13"
330 mm
↓



RDS WP 3104

30 Splines (Total Length 13" / 330 mm)
U J Cross Fitting : RSB 590 / SPR 2045 Series
RDS 218 / 218 GL (52 mm x 147 mm)
Application : Tata 4928 (Inter Axle Shaft)
List Price : Rs.5,820

30 Splines

↑
13"
330 mm
↓



RDS WP 3116

TEFLON COATED

30 Splines (Total Length 13" / 330 mm)
U. J. Cross Fitting : RSB 590 / SPR 2045 Series
RDS 218 / 218 GL (52 mm x 147 mm)
Application : Tata 4928 (Inter Axle Shaft)
List Price : Rs.

30 Splines

↑
14"
355 mm
↓



RDS WP 3105

30 Splines (Total Length 14" / 355 mm)
U J Cross Fitting : RSB 590 / SPR 2045 Series
RDS 218 / 218 GL (52 mm x 147 mm)
Application : Tata 4928 (Inter Axle Shaft)
List Price : Rs.5,820

30 Splines

↑
14"
355 mm
↓



RDS WP 3117

TEFLON COATED

30 Splines (Total Length 14" / 355 mm)
U. J. Cross Fitting : RSB 590 / SPR 2045 Series
RDS 218 / 218 GL (52 mm x 147 mm)
Application : Tata 4928 (Inter Axle Shaft)
List Price : Rs.

30 Splines

↑
15"
380 mm
↓



RDS WP 3114

30 Splines (Total Length 15" / 380 mm)
U. J. Cross Fitting : RSB 590 / SPR 2045 Series
RDS 218 / 218 GL (52 mm x 147 mm)
Application : Tata 4928 (Inter Axle Shaft)
List Price : Rs.

30 Splines

↑
15"
380 mm
↓



RDS WP 3118

TEFLON COATED

30 Splines (Total Length 15" / 380 mm)
U. J. Cross Fitting : RSB 590 / SPR 2045 Series
RDS 218 / 218 GL (52 mm x 147 mm)
Application : Tata 4928 (Inter Axle Shaft)
List Price : Rs.

WELCH PLUGS (Half Yoke & Rear Housing Assembly)

16"
400 mm



30 Splines

RDS WP 3119

30 Splines (Total Length 16" / 400 mm)
U. J. Cross Fitting : RSB 590 / SPR 2045 Series
RDS 218 / 218 GL (52 mm x 147 mm)
Application : Tata 4928 (Inter Axle Shaft)
List Price : Rs.

13.75"
350 mm



30 Splines

RDS WP 3107

30 Splines (Total Length 13.75" / 350 mm)
U J Cross Fitting : RSB 490 Series
RDS 111 / 111 GL (48 mm x 135 mm)
Application : Tata 4018 / 3118 (Inter Axle Shaft)
List Price : Rs.5,530

14.75"
375 mm



30 Splines

RDS WP 3108

30 Splines (Total Length 14.75" / 375 mm)
U J Cross Fitting : RSB 490 Series
RDS 111 / 111 GL (48 mm x 135 mm)
Application : Tata 4018 / 3118 (Inter Axle Shaft)
List Price : Rs.5,530

15.75"
400 mm



30 Splines

RDS WP 3109

30 Splines (Total Length 15.75" / 400 mm)
U J Cross Fitting : RSB 490 Series
RDS 111 / 111 GL (48 mm x 135 mm)
Application : Tata 4018 / 3118 (Inter Axle Shaft)
List Price : Rs.5,680

*Many more
to
come*

20 Teeth



RDS 1761

Tata 3718 / 3128 (Bolt Type) (20 Teeth)

Head Size : 4" / 95 mm

Total length : 6" / 150 mm

Bearing Size & No. : 60 mm / 88512, 6012

List Price : Rs.2,060

20 Teeth

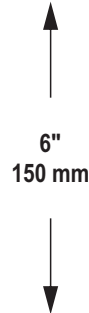

RDS 1762

Tata 3718 / 3128 (Bolt Type) (20 Teeth)

Head Size : 4.5" / 112 mm

Total length : 6" / 150 mm

Bearing Size & No. : 55 mm / 6211

List Price : Rs.2,200

26 Teeth



RDS 1763

Tata 4018 N/M / 4923 (26 Teeth)

Head Size : 4.5" / 112 mm

Total length : 7" / 178 mm

Bearing Size & No. : 55 mm / 6211

List Price : Rs.2,480

26 Teeth



RDS 1764

Tata 3718, 3118, 2518 (Bolt Type)

(26 Teeth) Head Size : 4" / 95 mm

Total length : 6" / 150 mm

Bearing Size & No. : 55 mm / 6211

List Price : Rs.1,930

26 Teeth

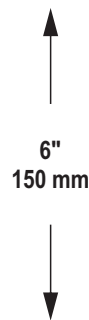

RDS 1765

Tata 3718, 3118, 2518, (Bolt Type)

(26 Teeth) Head Size : 4.5" / 112 mm

Total length : 6" / 150 mm

Bearing Size & No. : 55 mm / 6211

List Price : Rs.2,260

16 Teeth



RDS 159

Tata 3118 / 3116 / 4923 (16 Teeth)

Head Size : 4" / 95 mm

Total length : 7.5" / 190 mm

Bearing Size & No. : 60 mm / 88512, 6012

List Price : Rs.2,220

FRONT TEETH / MID SLIP STUB SHAFT

26 Teeth



RDS 6045

Tata 1312 / 1612 (26 Teeth)
 Head Size : 3.5" / 90 mm
 Total length : 8" / 200 mm
 Bearing Size & No. : 55 mm / 6211
 List Price : Rs.1,860

26 Teeth



RDS 707

Tata 2515 / 2416 Big Head (26 Teeth)
 Head Size : 4" / 95 mm
 Total length : 8" / 200 mm
 Bearing Size & No. : 55 mm / 6211
 List Price : Rs.2,100

26 Teeth



RDS 1769

Tata 3118 / 2518 (26 Teeth)
 Head Size : 4" / 95 mm
 Total length : 7" / 178 mm
 Bearing Size & No. : 55 mm / 6211
 List Price : Rs.1,950

26 Teeth



RDS 1766

Tata 1616 N/M
 (With long Collar) (26 Teeth)
 Head Size : 3.5" / 84 mm
 Total length : 8" / 200 mm
 Bearing Size & No. : 55 mm / 6211
 List Price : Rs.2,050

26 Teeth



RDS 1767

Tata 2518 (RSB Type) Big Head
 (With long Collar) (26 Teeth)
 Head Size : 4" / 95 mm
 Total length : 8" / 200 mm
 Bearing Size & No. : 55 mm / 6211
 List Price : Rs.2,060

10 Teeth



RDS 6086

Leyland 1613 Turbo / Tata 1510 TC
 (10 Teeth) Head Size : 3.5" / 84 mm
 Total length : 6" / 148 mm
 Bearing Size & No. : 45 mm / 88509
 List Price : Rs.1,520

FRONT TEETH / MID SLIP STUB SHAFT

16 Teeth



6.9"
175 mm

RDS 6231 B

Leyland Taurus 3516 (16 Teeth)
Head Size : 3.5" / 84 mm
Total length : 6.9" / 175 mm
Compatible with RDS 6228
Bearing Size & No. : 55 mm / 88509
List Price : Rs.1,720

16 Teeth



7"
180 mm

RDS 1768

Eicher 11.10 (16 Teeth)
Head Size : 3" / 71 mm
Total length : 7" / 180 mm
Bearing Size & No. : 55 mm / 6211
List Price : Rs.1,790

26 Teeth



7"
174 mm

RDS 716

Tata 2518 (Double Step) (26 Teeth)
Head Size : 4" / 95 mm
Total length : 7" / 174 mm
Bearing Size & No. : 65 mm / 6013
List Price : Rs.1,870

34 Teeth



6.25"
160 mm

RDS 6231 L

Leyland 2214 / 2516 (34 Teeth)
Head Size : 4" / 95 mm
Total length : 6.25" / 160 mm
Bearing Size & No. : 45 mm / 88509
List Price : Rs.1,660

34 Teeth



6.6"
166 mm

RDS 1770

Leyland 2214 TC AC, 2416 (34 Teeth)
(With Long Thread) (Thread Size M32 x 1.5)
(Spanner 41 No.) Head Size : 4" / 95 mm
Total length : 6.6" / 166 mm
Bearing Size & No. : 45 mm / 88509
List Price : Rs.1,780

10 Teeth



8"
204 mm

RDS 6149

Leyland Taskar 3" (10 Teeth)
Head Size : 3" / 71 mm
Total length : 8" / 204 mm
Bearing Size & No. : 45 mm / 88509
List Price : Rs.1,115

FRONT TEETH / MID SLIP STUB SHAFT

10 Teeth



8.8"
220 mm

RDS 6150

Leyland Taskar 3.5" (10 Teeth)
Head Size : 3.5" / 84 mm
Total length : 8.8" / 220 mm
Bearing Size & No. : 45 mm / 88509
List Price : Rs.1,340

34 Teeth



6.25"
158 mm

RDS 197

Tata 2518 (34 Teeth)
Head Size : 4" / 95 mm
Total length : 6.25" / 158 mm
Bearing Size & No. : 55 mm / 6211
List Price : Rs.1,800

34 Teeth



6.25"
158 mm

RDS 199

Tata 1616 (34 Teeth)
Head Size : 3.5" / 84 mm
Total length : 6.25" / 158 mm
Bearing Size & No. : 55 mm / 6211
List Price : Rs.1,800

46 Teeth



7.5"
189 mm

RDS 251

Tata 4018 (46 Teeth)
Head Size : 4" / 95 mm
Total Length : 7.5" / 189 mm
Bearing Size & No. 60 mm / 88512
Mating Centre Joint Flange RDS 957
List Price : Rs.2,270

39 Teeth



6.5"
165 mm

RDS 252

Leyland 3718, 2518 MSL Type
(39 Teeth) Head Size : 3.6" / 91.4 mm
Total Length : 6.5" / 165 mm
Bearing Size & No. 55 mm / 6211
Mating Centre Joint Flange RDS 956
List Price : Rs.2,270

34 Teeth



4.85"
125 mm

RDS 6261 C

Swaraj Mazda (39 Teeth)
Head Size : 2.8" / 71 mm
Total Length : 4.85" / 125 mm
Mating Centre Joint Flange RDS 6261 B
List Price : Rs.....

Propeller Shaft Components

SLEEVE YOKES & REAR TEETHS (LCVs Division)



RDS 402 T

Sleeve Yoke RDS 883, Rear Teeth RDS 893 T
Yoke & Teeth Set Tata 1109

(TEFLON COATED) (27 Splines)

(Cross Fitting L/Taskar, RDS 6202 B)

(U J Cross Dimensions 34.95 mm x 126 mm)

(Head Size 3.5" / 85 mm) (Bearing Size 45 mm)

List Price : Rs.4,300



RDS 883

Sleeve Yoke Tata 1109 (27 Splines)

(Cross Fitting L/Taskar, RDS 6202 B)

(U J Cross Dimensions 34.95 mm x 126 mm)

(Total Length 9.7" / 245 mm)

(Mating Rear Teeth RDS 893 T)

List Price : Rs.2,130



RDS 893 T

Rear Teeth Tata 1109 (27 Teeth)

(TEFLON COATED)

(Total Length 11" / 278 mm)

(Head Size 3.5" / 85 mm) (Bearing Size 45 mm)

(Mating Sleeve Yoke RDS 883)

List Price : Rs.2,180



RDS 403

Yoke & Teeth Set Tata 709 N/M

(TEFLON COATED) (22 Splines)

(Cross Fitting Tata 1210, RDS 6201)

(Head Size 2.5" / 64 mm) (Bearing Size 50 mm)

List Price : Rs.3,850



RDS 405 T

Sleeve Yoke RDS 885, Rear Teeth RDS 905

Yoke & Teeth Set Tata 712 / Marco Polo

(TEFLON COATED)

(16 Splines) (Cross Fitting L/Taskar, RDS 6202 B)

(U J Cross Dimensions 34.95 mm x 126 mm)

(Head Size 3" / 71 mm) (Bearing Size 40 mm)

List Price : Rs.3,100



RDS 885

Sleeve Yoke Tata 712 / Marco Polo

(Cross Fitting L/Taskar, RDS 6202 B) (16 Splines)

(U J Cross Dimensions 34.95 mm x 126 mm)

(Total Length 7.9" / 200 mm)

(Mating Rear Teeth RDS 905)

List Price : Rs.1,510



RDS 905

Rear Teeth Tata 712 / Marco Polo (16 Teeth)

(TEFLON COATED)

(Total Length 9.7" / 245 mm)

(Head Size 3" / 71 mm) (Bearing Size 40 mm)

(Mating Sleeve Yoke RDS 885)

List Price : Rs.1,610



RDS 203

Sleeve Yoke RDS 882, Rear Teeth RDS 892

Yoke & Teeth Set Tata 407 Pick Up

(MSL 1480 Series)

(16 Splines) (Cross Fitting RDS 201)

(U J Cross Dimensions 34.95 mm x 106 mm)

(Head Size 3.5" / 85 mm)

List Price : Rs.2,760



RDS 203 T

Sleeve Yoke RDS 882, Rear Teeth RDS 906

Yoke & Teeth Set Tata 407 Pick Up

(MSL 1480 Series) **(TEFLON COATED)**

(16 Splines) (Cross Fitting RDS 201)

(U J Cross Dimensions 34.95 mm x 106 mm)

(Head Size 3.5" / 85 mm)

List Price : Rs.3,020



RDS 882

Sleeve Yoke Tata 407 Pick Up

(MSL 1480 Series)

(16 Splines) (Cross Fitting RDS 201)

(U J Cross Dimensions 34.95 mm x 106 mm)

(Total Length 7.8" / 198 mm)

(Mating Rear Teeth RDS 892, 894 & RDS 906)

List Price : Rs.1,650



RDS 892

Rear Teeth Tata 407 Pick Up

(MSL 1480 Series) (16 Teeth)

(Total Length 7.5" / 190 mm)

(Head Size 3.5" / 85 mm)

(Mating Sleeve Yoke RDS 882)

List Price : Rs.1,110



RDS 906

Rear Teeth Tata 407 Pick Up

(MSL 1480 Series) (16 Teeth)

(TEFLON COATED)

(Total Length 7.5" / 190 mm)

(Head Size 3.5" / 85 mm)

(Mating Sleeve Yoke RDS 882)

List Price : Rs.1,370

Propeller Shaft Components

SLEEVE YOKES & REAR TEETHS (LCVs Division)



RDS 208

Sleeve Yoke RDS 882, Rear Teeth RDS 895
Yoke & Teeth Set Tata 407 Pick Up N/M
(16 Splines) (Cross Fitting RDS 201)
(U J Cross Dimensions 34.95 mm x 106 mm)
(Head Size 3" / 71 mm) (Bearing Size 35 mm)

List Price : Rs.2,760



RDS 210

Sleeve Yoke RDS 882, Rear Teeth RDS 894/718
Yoke & Teeth Set Tata 407 Pick Up N/M
(16 Splines) (Cross Fitting RDS 201)
(U J Cross Dimensions 34.95 mm x 106 mm)
(Head Size 3" / 71 mm) (Bearing Size 40 mm)

List Price : Rs.2,760



RDS 895

Rear Teeth Tata 407 Pick Up N/M (16 Teeth)
(Total Length 9" / 230 mm)
(Head Size 3" / 71 mm)
(Bearing Size 35 mm / No. 88507)
(Mating Sleeve Yoke RDS 882 & RDS 889)

List Price : Rs.1,180



RDS 6069 B

Sleeve Yoke RDS 884, Rear Teeth RDS 894 / 718
Yoke & Teeth Set Tata 407
Turbo Ex / 709 (Type 2) (16 Splines)
(Cross Fitting Canter N/M, RDS 6208)
(U J Cross Dimensions 30.17 mm x 106 mm)
(Head Size 3" / 71 mm) (Bearing Size 40 mm)

List Price : Rs.2,500



RDS 911

Sleeve Yoke RDS 884, Rear Teeth RDS 903
Yoke & Teeth Set Tata 407 Turbo (Type 2)
(TEFLON COATED) (16 Splines)
(Cross Fitting Canter N/M, RDS 6208)
(U J Cross Dimensions 30.17 mm x 106 mm)
(Head Size 3" / 71 mm) (Bearing Size 40 mm)

List Price : Rs.2,810



RDS 884/6233 A

Sleeve Yoke Eicher Canter N/M
Tata 407 Turbo Ex / 709 (Type 2) (16 Splines)
(Cross Fitting Canter N/M, RDS 6208)
(U J Cross Dimensions 30.17 mm x 106 mm)
(Total Length 7.6" / 193 mm)
(Mating R/Teeth RDS 894, 903, 6233 B & 6256 C)

List Price : Rs.1,310



RDS 894/718

Rear Teeth Tata 407 Turbo Ex / 709 (Type 2)
 (16 Teeth) (Total Length 9" / 230 mm)
 (Head Size 3" / 71 mm) (Bearing Size 40 mm)
 (Mating Sleeve Yoke RDS 884 & RDS 882)

List Price : Rs.1,180

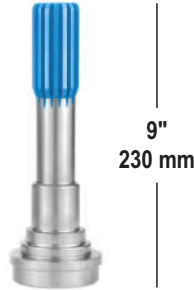

RDS 903

Rear Teeth Tata 407 Turbo Ex / 709 (Type 2)
(TEFLON COATED)
 (16 Teeth) (Total Length 9" / 230 mm)
 (Head Size 3" / 71 mm) (Bearing Size 40 mm)
 (Mating Sleeve Yoke RDS 884)

List Price : Rs.1,560



RDS 207 T

Sleeve Yoke RDS 889, Rear Teeth RDS 895 T
 Yoke & Teeth Set Tata 407 Turbo (Type 2)
(TEFLON COATED) (16 Thin Splines)
 (Cross Fitting Canter N/M, RDS 6208)
 (U J Cross Dimensions 30.17 mm x 106 mm)
 (Head Size 3" / 71 mm) **(Bearing Size 35 mm)**

List Price : Rs.2,810



RDS 889

Sleeve Yoke Tata 407 Turbo EX (Type 2)
 (16 Thin Splines) (Total Length 7.6" / 193 mm)
 (Cross Fitting Canter N/M, RDS 6208)
 (U J Cross Dimensions 30.17 mm x 106 mm)
 (Mating Rear Teeth RDS 895 T)

List Price : Rs.1,365



RDS 895 T

Rear Teeth 407 Turbo EX (Type 2)
(TEFLON COATED)
 (16 Thin Teeth) (Total Length 9" / 230 mm)
 (Head Size 3" / 71 mm) (Bearing Size 35 mm)
 (Mating Sleeve Yoke RDS 889)

List Price : Rs.1,560



RDS 6069 C

Sleeve Yoke RDS 881, Rear Teeth RDS 891 / 720
 Yoke & Teeth Set Tata 407 Turbo
 MSL Design (Type 3) (16 Splines)
 (Cross Fitting DCM N/M, RDS 6212)
 (U J Cross Dimensions 30.17 mm x 92 mm)
 (Head Size 3" / 71 mm) (Bearing Size 35 mm)

List Price : Rs.2,255



RDS 912

Sleeve Yoke RDS 881, Rear Teeth RDS 904
Yoke & Teeth Set Tata 407 Turbo
MSL Design (Type 3) (16 Splines)
(TEFLON COATED)
(Cross Fitting DCM N/M, RDS 6212)
(U J Cross Dimensions 30.17 mm x 92 mm)
(Head Size 3" / 71 mm) (Bearing Size 35 mm)
List Price : Rs.2,495



RDS 881

Sleeve Yoke Tata 407 Turbo
MSL Design (Type 3) (16 Splines)
(Cross Fitting DCM N/M, RDS 6212)
(U J Cross Dimensions 30.17 mm x 92 mm)
(Total Length 6.6"/168 mm)
(Mating Rear Teeth RDS 891 & RDS 904)
List Price : Rs.1,200

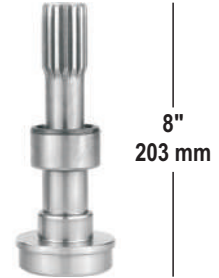

RDS 891/720

Rear Teeth Tata 407 Turbo
MSL Design (Type 3) (16 Teeth)
(Head Size 3" / 71 mm) (Bearing Size 35 mm)
(Total Length 8"/203 mm)
(Mating Sleeve Yoke RDS 881)
List Price : Rs.1,070

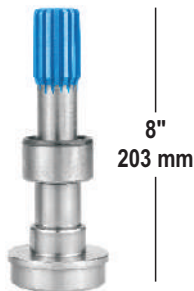

RDS 904

Rear Teeth Tata 407 Turbo
MSL Design (Type 3) (16 Teeth)
(TEFLON COATED)
(Head Size 3" / 71 mm) (Bearing Size 35 mm)
(Total Length 8"/203 mm)
(Mating Sleeve Yoke RDS 881)
List Price : Rs.1,370



RDS 6256 A

Sleeve Yoke RDS 884, Rear Teeth RDS 6233 B
Yoke & Teeth Set Eicher Canter 10.60, 10.90, 10.95
(16 Splines) (Cross Fitting Canter N/M, RDS 6208)
(U J Cross Dimensions 30.17 mm x 106 mm)
(Head Size 3" / 71 mm)
List Price : Rs.2,330



RDS 6256 B

Sleeve Yoke RDS 884, Rear Teeth RDS 6256 C
Yoke & Teeth Set Eicher Canter 10.60, 10.90, 10.95
(TEFLON COATED) (16 Splines)
(Cross Fitting Canter N/M, RDS 6208)
(U J Cross Dimensions 30.17 mm x 106 mm)
(Head Size 3" / 71 mm)
List Price : Rs.2,330



RDS 6233 B

Rear Teeth Eicher Canter 10.60, 10.90, 10.95
(16 Teeth) (Total Length 6.7"/170 mm)
(Head Size 3" / 71 mm)
(Mating Sleeve Yoke RDS 884)
List Price : Rs.1,025



RDS 6256 C

Rear Teeth Eicher Canter 10.60, 10.90, 10.95
(TEFLON COATED) (16 Teeth)
(Total Length 6.7"/170 mm)
(Head Size 3" / 71 mm)
(Mating Sleeve Yoke RDS 884)
List Price : Rs.1,090



RDS 408

Yoke & Teeth Set Eicher PRO / Tata Ultra
(22 Splines) **(TEFLON COATED)**
(Cross Fitting Tata 407 Pickup, RDS 201)
(U J Cross Dimensions 34.95 mm x 106 mm)
(Head Size 3.5" / 85 mm) (Bearing Size 40 mm)
List Price : Rs.3,900



RDS 205

Yoke & Teeth Set Tata 407
Turbo N/M / City Ride (16 Splines)
(Cross Fitting Tata 407, RDS 6201 B)
(U J Cross Dimensions 30 mm x 82 mm)
(Head Size 2.1" / 54 mm) (Bearing Size 35 mm)
List Price : Rs.1,870



RDS 565

Sleeve Yoke RDS 6145, Rear Teeth RDS 901
Yoke & Teeth Set Eicher Jumbo 11.10
(TEFLON COATED) (16 Splines)
(Cross Fitting L/Taskar, RDS 6202 B)
(U J Cross Dimensions 34.95 mm x 126 mm)
(Head Size 3" / 71 mm)
List Price : Rs.3,410



RDS 566

Sleeve Yoke RDS 6145, Rear Teeth RDS 902
Yoke & Teeth Set Eicher Jumbo 11.14 XP
(TEFLON COATED) (16 Splines)
(Cross Fitting L/Taskar, RDS 6202 B)
(U J Cross Dimensions 34.95 mm x 126 mm)
(Head Size 3.5" / 85 mm)
List Price : Rs.3,610



7.9"
200 mm

RDS 6145

Sleeve Yoke Eicher Jumbo 11.10 / L/Taskar
(16 Splines) (Cross Fitting L/Taskar, RDS 6202 B)
(U J Cross Dimensions 34.95 mm x 126 mm)
(Total Length 7.9" / 200 mm)
(Mating R/Teeth RDS 901, 902, 6145 A & 6145 B)

List Price : Rs.1,770



7.7"
195 mm

RDS 901

Rear Teeth Eicher Jumbo 11.10, L/Taskar
(TEFLON COATED) (16 Teeth)
(Head Size 3" / 71 mm)
(Total Length 7.7"/195 mm)
(Mating Sleeve Yoke RDS 6145)

List Price : Rs.1,550



7.7"
195 mm

RDS 902

Rear Teeth Eicher Jumbo 11.14 XP, L/Taskar
(TEFLON COATED) (16 Teeth)
(Head Size 3.5" / 85 mm)
(Total Length 7.7"/195 mm)
(Mating Sleeve Yoke RDS 6145)

List Price : Rs.1,710



11.1"
283 mm

10.55"
268 mm

RDS 564 T

Sleeve Yoke RDS 886, Rear Teeth RDS 896 T
Yoke & Teeth Set Eicher Terra
(TEFLON COATED) (28 Splines)
(Cross Fitting L/Taskar RDS 6202 B)
(U J Cross Dimensions 34.95 mm x 126 mm)
(Head Size 3.5" / 85 mm)

List Price : Rs.4,430



11.1"
283 mm

RDS 886

Sleeve Yoke Eicher Terra (28 Splines)
(Cross Fitting L/Taskar RDS 6202 B)
(U J Cross Dimensions 34.95 mm x 126 mm)
(Total Length 11.1" / 283 mm)
(Mating Rear Teeth RDS 896 T)

List Price : Rs.2,360



10.55"
268 mm

RDS 896 T

Rear Teeth Eicher Terra (28 Teeth)
(TEFLON COATED)
(Head Size 3.5" / 85 mm)
(Total Length 10.55"/268 mm)
(Mating Sleeve Yoke RDS 886)

List Price : Rs.2,375



RDS 567

Sleeve Yoke RDS 887, Rear Teeth RDS 897
Yoke & Teeth Set Eicher PRO 10.80 / Tata 909
(TEFLON COATED) (22 Splines)
(Cross Fitting RDS 201)
(U J Cross Dimensions 34.95 mm x 106 mm)
(Head Size 3.5" / 85 mm)
List Price : Rs.3,370



RDS 887

Sleeve Yoke Eicher PRO 10.80 / Tata 909
(22 Splines) (Cross Fitting RDS 201)
(U J Cross Dimensions 34.95 mm x 106 mm)
(Total Length 9" / 228 mm)
(Mating Rear Teeth RDS 897)
List Price : Rs.1,740



RDS 897

Rear Teeth Eicher PRO 10.80 / Tata 909
(22 Teeth) (TEFLON COATED)
(Head Size 3.5" / 85 mm)
(Total Length 8.7"/220 mm)
(Mating Sleeve Yoke RDS 887)
List Price : Rs.1,700



RDS 571

Yoke & Teeth Set Mahindra Bolero DI / SLX FB
Jeep 6" (TEFLON COATED) (16 Splines)
(Cross Fitting Jeep Diesel, RDS 6210 A)
(U J Cross Dimensions 27 mm x 82 mm)
(Head Size 60 mm) (MSL Ref. No. 3220431 / 432)
List Price : Rs.1,880



RDS 572

Yoke & Teeth Set Mahindra Utility FC / NC
Jeep 7" (TEFLON COATED) (16 Splines)
(Cross Fitting Jeep Diesel, RDS 6210 A)
(U J Cross Dimensions 27 mm x 82 mm)
(Head Size 60 mm) (MSL Ref. No. 3220452/472)
List Price : Rs.1,920



RDS 573

Yoke & Teeth Set Mahindra Max Pickup
(TEFLON COATED) (16 Splines)
(Cross Fitting Jeep Diesel, RDS 6210 A)
(U J Cross Dimensions 27 mm x 82 mm)
(Head Size 71 mm) (MSL Ref. No. 3220463/492)
List Price : Rs.1,950



RDS 574

Yoke & Teeth Set Mahindra Bolero DI / XYLO

(TEFLON COATED) (16 Splines)

(Cross Fitting Jeep Diesel, RDS 6210 A)

(U J Cross Dimensions 27 mm x 82 mm)

(Head Size 60 mm) (MSL Ref. No. 3220469)

(Bearing Size 35 mm)

List Price : Rs.2,060



RDS 211

Sleeve Yoke & Teeth Tata Yodha

(TEFLON COATED) (16 Splines)

(Cross Fitting Jeep Diesel, RDS 6210 A)

(U J Cross Dimensions 27 mm x 82 mm)

(Rear Teeth Head Size 2.38" / 60.50 mm)

List Price : Rs.2,930

*Many more
to come*

Propeller Shaft Components

SLEEVE YOKES & REAR TEETHS (HCVs Division)

16 Thick Splines



13.25"
336 mm

RDS 141 L

Propeller Shaft Sleeve Yoke

Tata 4018 / 3118 Long, AMW 2518 (16 Thick Splines)
(Total Length 13.25" / 336 mm) U.J. Cross Fitting : RDS 601
(Tata 4018 Patti Type, 49.20 mm x 154.80 mm)
Mating Rear Teeth : RDS 147A / 147T

List Price : Rs.4,860

16 Thick Splines



13.8"
350 mm

RDS 145 A

Sleeve Yoke (Inter Axle Shaft)

Tata L / L 1710 Series
(16 Thick Splines) (Total Length 13.8" / 350 mm)
U.J. Cross Fitting : RDS 6202 H (41.28 mm x 126 mm)
Mating Rear Teeth : RDS 147 A / 147 T

List Price : Rs.4,210

16 Thick Splines



13.5"
343 mm

RDS 145

Sleeve Yoke (Inter Axle Shaft)

Tata L / L 1710 Series (16 Thick Splines)
(Total Length 13.5" / 343 mm)
U.J. Cross Fitting : Leyland Taskar
(RDS 6202 B, 34.95 mm x 126 mm)
Mating Rear Teeth : RDS 147 A / 147 T

List Price : Rs.3,920

16 Teeth



11.6"
295 mm

RDS 147 A

Propeller Shaft Rear Teeth

Tata 4018 / 3118 (Long) (16 Teeth)
(Head Size 4" / 95 mm)
(Total Length 11.6" / 295 mm)
Mating Sleeve Yoke : RDS 141 L, 145, 145 A

List Price : Rs.2,890

16 Teeth



11.6"
295 mm

RDS 147 T

Propeller Shaft Rear Teeth

Tata 3118 / 4018 (Long) **(TEFLON COATED)**
(16 Teeth) (Head Size 4" / 95 mm)
(Total Length 11.6" / 295 mm)

Mating Sleeve Yoke : RDS 141 L, 145, 145 A

List Price : Rs.3,530

30 Splines



11.8"
300 mm

RDS 6231 F

Sleeve Yoke Leyland 2214 / 2516 / Eicher Galaxy
(30 Splines) (Total Length 11.8" / 300 mm)
U.J. Cross Fitting : RDS 6202 H (41.28 mm x 126 mm)
Mating Rear Teeth : RDS 6231 G, RDS 131, RDS 126
List Price : Rs.2,470

30 Splines



9.85"
250 mm

RDS 001

Sleeve Yoke Tata 2515 Hywa / L / L 3516
(30 Splines) (Total Length 9.85" / 250 mm)
U.J. Cross Fitting : RDS 6202 H (41.28 mm x 126 mm)
Mating Rear Teeth : RDS 002 T, RDS 6231 G
List Price : Rs.2,780

30 Splines



9"
227 mm

RDS 907

Real Teeth Tata 1616, LP 1613
(30 Teeth) (Half Splines) (TEFLON COATED)
(Head Size 3.5" / 84 mm)
Mating Sleeve Yoke : RDS 6231 F, RDS 001
List Price : Rs.2,230

30 Teeth



10.5"
268 mm

RDS 6231 G

Rear Teeth Leyland 2214 / 2516 / Eicher Galaxy
(30 Teeth) (Half Splines)
(Head Size 4" / 95 mm)
(Total Length 10.5" / 268 mm)
Mating Sleeve Yoke : RDS 6231 F, RDS 001
List Price : Rs.2,040

30 Teeth



10.5"
268 mm

RDS 131

Rear Teeth Leyland 2214 / 2516
(30 Teeth) **(FULL SPLINES)**
(Head Size 4" / 95mm)
(Total Length 10.5" / 268 mm)
Mating Sleeve Yoke : RDS 6231 F, RDS 001
List Price : Rs.2,040

30 Teeth



10.5"
268 mm

RDS 126

Rear Teeth Leyland 2214 / 2516
(30 Teeth) (Half Splines) **(TEFLON COATED)**
(Head Size 4" / 95 mm)
(Total Length 10.5" / 268 mm)
Mating Sleeve Yoke : RDS 6231 F, RDS 001
List Price : Rs.2,460

Propeller Shaft Components

SLEEVE YOKES & REAR TEETHS (HCVs Division)

16 Splines



11.8"
300 mm

RDS 6244

Propeller Shaft Sleeve Yoke

Tata 2515 / L / L 2214 (16 Splines) Heavy Duty

(Total Length 11.8" / 300 mm)

U.J. Cross Fitting : RDS 6202 H (41.28 mm x 126 mm)

Mating Rear Teeth : RDS 6245, RDS 132, RDS 132 T

List Price : Rs.2,510

16 Teeth



10.5"
268 mm

RDS 6245

Rear Teeth Leyland 2214 / 2516

(16 Teeth, Heavy Duty) Half Splines

Head Size 4" / 95 mm (Total Length 10.5" / 268 mm)

Mating Sleeve Yoke : RDS 6244

List Price : Rs.2,040

16 Teeth



10.5"
268 mm

RDS 132

Rear Teeth Tata 2515, Leyland 2214 / 2516

(16 Teeth, Heavy Duty) **FULL SPLINES**

Head Size 4" / 95 mm (Total Length 10.5" / 268 mm)

Mating Sleeve Yoke : RDS 6244

List Price : Rs.2,040

16 Teeth



10.5"
268 mm

RDS 132 T

Rear Teeth Tata 2515, Leyland 2214 / 2516

(TEFLON COATED) (16 Teeth, Heavy Duty) Full Splines

Head Size 4" / 95 mm (Total Length 10.5" / 268 mm)

Mating Sleeve Yoke : RDS 6244

List Price : Rs.2,540

Propeller Shaft Components

SLEEVE YOKES & REAR TEETHS (HCVs Division)

30 Teeth



RDS 552

(Sleeve Yoke RDS 6231 F + Rear Teeth RDS 6231 G)
Leyland 2214 / 2516, Eicher Galaxy
(30 Teeth) (Half Splines)
U.J. Cross Fitting : RDS 6202 H (41.28 mm x 126 mm)
List Price : Rs.4,820

30 Teeth



RDS 550 T

(Sleeve Yoke RDS 6231 F + Rear Teeth RDS 126)
Leyland 2214 / 2516, Eicher Galaxy
TEFLON COATED (30 Teeth) (Half Splines)
U.J. Cross Fitting : RDS 6202 H (41.28 mm x 126 mm)
List Price : Rs.5,240

16 Teeth



RDS 551

(Sleeve Yoke RDS 6244 + Rear Teeth RDS 132)
Tata 2515 / Leyland 2516, 2214
(Heavy Duty) (16 Teeth) (Full Splines)
U.J. Cross Fitting : RDS 6202 H (41.28 mm x 126 mm)
List Price : Rs.4,860

16 Teeth



RDS 551 T

(Sleeve Yoke RDS 6244 + Rear Teeth RDS 132 T)
Tata 2515 / Leyland 2516, 2214 (Heavy Duty)
TEFLON COATED (16 Teeth) (Full Splines)
U.J. Cross Fitting : RDS 6202 H (41.28 mm x 126 mm)
List Price : Rs.5,360

16 Splines



10.5"
265 mm

RDS 6042

Tata 1312 / 1612 / 1510
(16 Splines) (Total Length 10.5" / 265 mm)

U.J. Cross Fitting : RDS 6201 A
(46.05 mm x 69 mm)

Mating Rear Teeth : RDS 6043

List Price: Rs.2,410

24 Splines



10.5"
265 mm

RDS 6042 B

Tata 1312 / 1612 / 1510 (Spicer Design)
(24 Splines) (Total Length 10.5" / 265 mm)

U.J. Cross Fitting : RDS 6201 A
(46.05 mm x 69 mm)

Mating Rear Teeth : RDS 6043 B

List Price: Rs.2,510

16 Splines



12.4"
315 mm

RDS 6042 A

Tata 1312 / 1612 / 1510 (Extra Long)
(16 Splines) (Total Length 12.4" / 315 mm)

U.J. Cross Fitting : RDS 6201 A
(46.05 mm x 69 mm)

Mating Rear Teeth : RDS 6043 A

List Price : Rs.3,220

16 Teeth



11.3"
288 mm

RDS 6043

Tata 1312, 1612, 1510
(16 Teeth) (Full Splines)
(Head Size 3.5" / 84 mm)
(Total Length 11.3" / 288 mm)

Mating Sleeve Yoke : RDS 6042

List Price : Rs.2,125

24 Teeth



10.8"
275 mm

RDS 6043 B

Tata 1312, 1612, 1510 (Spicer Design)
(24 Teeth) (Half Splines)
(Head Size 3.5" / 84 mm)
(Total Length 10.8" / 275 mm)

Mating Sleeve Yoke : RDS 6042 B

List Price : Rs.2,170

16 Teeth



13.4"
340 mm

RDS 6043 A

Tata 1312 / 1612 / 1510 (Extra Long)
(16 Teeth) (Full Splines)
(Head Size 3.5" / 84 mm)
(Total Length 13.4" / 340 mm)

Mating Sleeve Yoke : RDS 6042 A

List Price : Rs.2,270

Propeller Shaft Components

SLEEVE YOKES & REAR TEETHS (HCVs Division)

16 Splines



10.8"
275 mm

RDS 151

Sleeve Yoke Leyland 1613 N/M, E Comet
(16 Splines) (Total Length 10.8" / 275 mm)
U.J. Cross Fitting : RDS 6202 B (34.95 mm x 126 mm)
Mating Rear Teeth : RDS 152, RDS 152 F
List Price : Rs.2,240

16 Splines



9.85"
250 mm

RDS 888

Sleeve Yoke Leyland 1613 Turbo, EURO II
(16 Splines) (Total Length 9.85" / 250 mm)
U.J. Cross Fitting : RDS 6202 B (34.95 mm x 126 mm)
Mating Rear Teeth : RDS 898, RDS 152, RDS 152 F
List Price : Rs.2,240

16 Teeth



9.85"
250 mm

RDS 152 F

Rear Teeth Leyland 1613 N/M, E Comet
(Full Splines) (16 Teeth)
(Total Length 9.85" / 250 mm)
(Head Size 3.5" / 84 mm)
Mating Sleeve Yoke : RDS 151
List Price: Rs.1,580

16 Teeth



9.85"
250 mm

RDS 152

Rear Teeth Leyland 1613 N/M, E Comet
(Half Splines) (16 Teeth)
(Total Length 9.85" / 250 mm)
(Head Size 3.5" / 84 mm)
Mating Sleeve Yoke : RDS 151
List Price: Rs.1,580

16 Teeth



9.1"
230 mm

RDS 898

Rear Teeth L/L1613 Turbo, E Comet / STAG
(16 Teeth) (Full Splines)
(Head Size 3.5" / 84 mm)
(Total Length 9.1" / 230 mm)
Mating Sleeve Yoke : RDS 888, RDS 151
List Price: Rs.1,580

16 Thick Splines



11.1"
282 mm

RDS 141

Propeller Shaft Sleeve Yoke

Tata 4018 / 3118 (SMALL) (16 Thick Splines)

(Total Length 11.1" / 282 mm) U.J. Cross Fitting : RDS 601

(Tata 4018 Patti Type, 49.20 mm x 154.80 mm)

Mating Rear Teeth : RDS 142

List Price : Rs.4,650

16 Thick Teeth



10.2"
260 mm

RDS 142

Rear Teeth Tata 4018 / 3118 (SMALL)

(16 Thick Teeth)

(Head Size 4" / 95 mm)

(Total Length 10.2" / 260 mm)

Mating Sleeve Yoke : RDS 141

List Price : Rs.2,880

*Many more
to come*



RDS 981
Tata GB - 60
(Steel Forged Heavy Duty)
List Price : Rs. 1,260



RDS 982
Tata GB - 75
List Price : Rs. 1,160



RDS 983
Tata 3118, 4018 (GB - 1150)
List Price : Rs. 1,520



RDS 987
Tata 3718 (GB - 1150 Heavy Duty)
List Price : Rs. 1,630

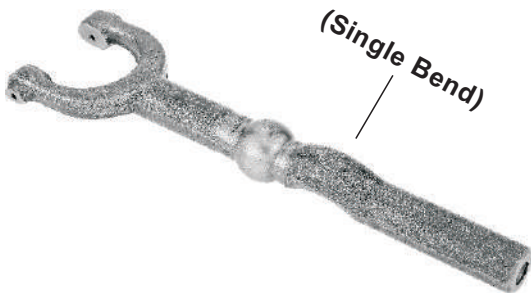

RDS 984
Tata 1109 (Single Bend)
List Price : Rs. 900

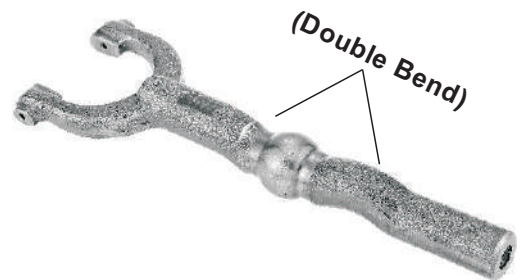

RDS 985
Tata 1109 (1150 Double Bend)
List Price : Rs. 950



RDS 986

Tata 709 / 1109 (Inner Thread)
List Price : Rs. 870



RDS 6054 L

Tata 1613 TC (LONG)
List Price : Rs. 1,040



RDS 6054

Tata 1613 TC (SMALL)
List Price : Rs. 998



RDS 6047

Tata 1612 / 1510
List Price : Rs. 870



RDS 6022

Tata GBS - 40
List Price : Rs. 870



RDS 6021

Tata 1210
List Price : Rs.



RDS 6071

Tata 407

List Price : Rs. 832

STRAIGHT ARM



RDS 988

Tata 3118 (Left)
(Steel Forged Heavy Duty)
List Price : Rs. .2,200



RDS 989

Tata 3118 (Right)
(Steel Forged Heavy Duty)
List Price : Rs. 2,200

| Part No. | Description | LIST PRICE |
|----------|--|---------------|
| RDS 6001 | Sleeve Yoke Assy. 1210 SE..... | 3,400.00 Set |
| RDS 6002 | Half Yoke Assy. 1210..... | 2,760.00 Set |
| RDS 6003 | Half Yoke Assy. SE Model 3"..... | 2,820.00 Set |
| RDS 6004 | Sleeve Yoke Tata 1210..... | 1,680.00 Each |
| RDS 6005 | Rear Teeth 1210/608 2½"..... | 1,260.00 Each |
| RDS 6006 | Rear Teeth SE Model 3"..... | 1,390.00 Each |
| RDS 6007 | Cross Holder Tata 1210/SE..... | 880.00 Each |
| RDS 6008 | Stub Ball Half Yoke End Tata 1210 2½"..... | 1,040.00 Each |
| RDS 6009 | Stub Ball Half Yoke Tata SE 3"..... | 1,090.00 Each |
| RDS 6010 | Centre Coupling Tata 1210/608..... | 755.00 Each |
| RDS 6011 | Center Coupling Tata SE..... | 765.00 Each |
| RDS 6012 | Gear Coupling Tata SE/GB-40..... | 700.00 Each |
| RDS 6013 | Gear Coupling Tata 1210/608..... | 755.00 Each |
| RDS 6014 | Differential Coupling Tata 1210 SE..... | 700.00 Each |
| RDS 6015 | Differential Coupling Tata 608..... | 700.00 Each |
| RDS 6016 | Front Teeth W/Nut Tata SE 3"..... | 1,330.00 Each |
| RDS 6017 | Front Teeth W/Nut Tata 1210/608 2½"..... | 1,310.00 Each |
| RDS 6020 | Clutch Fork Tata 1210..... | Each |
| RDS 6021 | Clutch Fork G.B. 30 Long..... | Each |
| RDS 6022 | Clutch Fork G.B. 40 Small..... | 870.00 Each |
| RDS 6026 | Pitman ARM Tata SE Truck..... | 880.00 Each |
| | | |
| | | |
| | | |
| | | |
| | | |

| Part No. | Description | LIST PRICE |
|-------------------|---|---------------------|
| RDS 6035 | Sleeve Yoke Assy..... | 5,470.00 Set |
| RDS 6036 | Half Yoke Assy (90 mm Dia)..... | 4,410.00 Set |
| RDS 6036 A | Half Yoke Assy (76 mm Dia)..... | 4,410.00 Set |
| RDS 6037 | Cross Holder 1312 (8 Holes)..... | 1,520.00 Each |
| RDS 6037A | Cross Holder Latest Model (6 Holes)..... | 1,520.00 Each |
| RDS 6038 | Half Yoke End 90 mm Dia (3½" Pipe Size)..... | 1,560.00 Each |
| RDS 6038 A | Half Yoke End 76 mm (3" Pipe Size) | 1560.00 Each |
| RDS 6039 | Differential Coupling Flange | 860.00 Each |
| RDS 6040 | Centre Jhoola Coupling | 815.00 Each |
| RDS 6040 A | Centre Coupling 2416 N/M Extra Long Height..... | 1,060.00 Each |
| RDS 6041 | Gear Box Coupling 1312..... | 860.00 Each |
| RDS 6042 | Sleeve Yoke 1312..... | 2,410.00 Each |
| RDS 6042 A | Sleeve Yoke Tata 1312 Extra Long..... | 3,220.00 Each |
| RDS 6043 | Rear Teeth 1312..... | 2,125.00 Each |
| RDS 6043 A | Rear Teeth Tata 1312 Extra Long..... | 2,270.00 Each |
| RDS 559 | Yoke & Teeth Set Tata 1312..... | 4,745.00 Each |
| RDS 6045 | Front Teeth 1312..... | 1,860.00 Each |
| RDS 6046 | Clutch Fork Tata 1312 | 832.00 Each |
| RDS 6047 | Clutch Fork Tata 1612/1510 | 870.00 Each |
| RDS 6043 B | Rear Teeth Tata 1312 Latest (24 Teeth) (Spicer Shaft)..... | 2,170.00 Each |
| RDS 6042 B | Sleeve Yoke Tata 1312 Latest (24 Splines) (Spicer Shaft)..... | 2,510.00 Each |
| RDS 6054 | Clutch Fork Tata 1613 TC..... | 998.00 Each |
| RDS 6054 L | Clutch Fork Tata 1613 TC (Long)..... | 1040.00 Each |
| RDS 129 | Pitman Arm Tata 1613 TC..... | 1,075.00 Each |
| | | |
| | | |

| Part No. | Description | LIST PRICE |
|----------------|---|-----------------|
| RDS 6056 | Sleeve Yoke Assy. (1 Yoke, 1Cross, 1Holder)..... | 2,300 Set |
| RDS 6057 | Half Yoke Assy. (1 Half Yoke, 1 Cross, 1 Holder)..... | 1,945 Set |
| RDS 6057 A | Half Yoke Assy. 407 N/M..... | 2,850 Set |
| RDS 6058 | Flange Yoke Cross Holder Tata 407..... | 720 Each |
| RDS 136 | Cross Holder 407 Turbo (6 Hole Plate Size 1210) (Cross Fitting Canter N/M)..... | 990 Each |
| RDS 6060 | Stub Ball Half Yoke End Tata 407..... | 670 Each |
| RDS 6061 | Stub Ball Half Yoke End N/M 1210 Type..... | 1,040 Each |
| RDS 6062 | Centre Jhoola Coupling Flange 407 O/M..... | 525 Each |
| RDS 6062 A | Centre Jhoola Coupling Flange 407 N/M..... | 755 Each |
| RDS 6063 | Diff. Coupling Flange 407 O/M..... | 525 Each |
| RDS 6064 | Diff. Coupling Flange 407 N/M 1210 Type..... | 755 Each |
| RDS 6065 | Gear Box Coupling Flange 407 O/M..... | 525 Each |
| RDS 6065 A | Gear Box Coupling Flange 407 N/M..... | 755 Each |
| RDS 6066 | Sleeve Yoke 407..... | 990 Each |
| RDS 6067 | Rear Teeth 407..... | 810 Each |
| RDS 6068 | Front Teeth (With Nut) 407..... | Each |
| RDS 6069 | P.S.. Sleeve Yoke & Teeth 407..... | 1,790 Each |
| RDS 6069 A | P.S. Yoke & Teeth Tata Turbo 407 (Cross Fitting D/Jeep)..... | Each |
| RDS 6071 | Clutch Fork 407..... | 832 Each |
| RDS 715 | Cross Holder Tata 407 Turbo (Type 3) (Cross Fitting DCM N/M, 30.18 mm x 90 mm) | |
| | (Plate Size 100 mm, 6 Holes, Hole Dia 10.20 mm)..... | 890 Each |

| Part No. | Description | LIST PRICE |
|---------------------------|--|------------|
| RDS 037 | Cross Holder Tata ACE | 520 Each |
| RDS 038 | Half Yoke Tata ACE | 405 Each |
| RDS 039 | Sleeve Yoke Tata ACE | 825 Each |
| RDS 040 A | Half Yoke Ass. ACE (1 Half Yoke, 1 C/Holder, 1 U.J. Cross)..... | 1370 Set |
| RDS 040 B | Full Yoke Assy. (1 Sleeve Yoke, 1 U.J. Cross & 1 Half Yoke) | Set |
| RDS 041 A | Differential Coupling ACE O/M | Each |
| TATA ACE N/M MAGIC | | |
| RDS 037 A | Cross Holder Tata ACE N/M Magic | 512 Each |
| RDS 038 A | Half Yoke Tata ACE N/M Magic | 464 Each |
| RDS 039 A | Sleeve Yoke Tata ACE N/M Magic | 890 Each |
| RDS 041 B | Differential Coupling ACE N/M Magic | Each |
| RDS 040 AM | Half Yoke Ass. ACE N/M Magic (1 Half Yoke, 1 C/Holder, 1 U.J. Cross) | 1,400 Set |
| RDS 040 BM | Full Yoke Assy. ACE N/M Magic(1 Sleeve Yoke, 1 U.J.Cross & 1Half Yoke). | 1,750 Set |
| AMBASSADOR | | |
| RDS 6186 | Sleeve Yoke Assy. (1 Cross, 1 Yoke, 1 Holder) | 1,660 Set |
| RDS 6186 A | Half Yoke Assy. (1 Cross, 1 Half Yoke, 1 Holder)..... | 1,455 Set |
| RDS 6187 | Propeller Shaft Sleeve Yoke & Teeth Ambassador | 1,350Set |
| RDS 6188 | Stub Ball Half Half Yoke End Ambassador | 515 Each |
| RDS 6189 | Flange Yoke Cross Holder Ambassador | 512 Each |
| RDS 6192 | Propeller Shaft Rear Sleeve Yoke Ambassador | 700 Each |
| RDS 6193 | Propeller Shaft Rear Teeth Ambassador..... | 630 Each |

LEYLAND TASKER

| Part No. | Description | LIST PRICE |
|--------------------------------------|--|-------------|
| RDS 6141 | Sleeve Yoke Assy. Leyland Tasker (1 Yoke, 1 Cross, 1 Holder) | 3,800 Set |
| RDS 6142 | Half Yoke Assy. 3" (1 Half Yoke, 1 Cross, 1 Holder) Leyland Tasker)..... | 3,250 Set |
| RDS 6142 A | Half Yoke Assy. 3½" (1 Half Yoke, 1 Cross, 1 Cross Holder)..... | 3,390 Set |
| RDS 6143 | Flange Yoke Cross Holder Leyland Tasker (MSL) Type | 1,050 Each |
| RDS 6144 | Stub Ball Half Yoke End Leyland Tasker (MSL) Type 3" | 1,240 Each' |
| RDS 6145 | Sleeve Yoke Leyland Tasker (MSL Type) | 1,770 Each |
| RDS 6145 A | Rear Teeth L/Taskar 3" Full Splines | 1,220 Each |
| RDS 6145 AH | Rear Teeth L/Taskar 3" Half Splines..... | 1,220 Each |
| RDS 6145 B | Rear Teeth L/Taskar 3½" Full Splines | 1,510 Each |
| RDS 6145 BH | Rear Teeth L/Taskar 3½" Half Splines | 1,510 Each |
| RDS 6146 | Stub Ball Half Yoke End Leyland Tasker (3½" Base) | 1,390 Each |
| RDS 6148 | Center Coupling L/L Tasker 10 Splines | 1,170 Each |
| RDS 6149 | Prop. Shaft Front Teeth 10 Spline (3" Base)..... | 1,115 Each |
| RDS 6150 | Prop. Shaft Front Teeth 10 Spline (3½" Base) | 1,340 Each |
| LEYLAND TAURAS / LEYLAND 3516 | | |
| RDS 6218 | Sleeve Yoke Assy. Lock | 6,620 Set |
| RDS 6220 | Half Yoke Assy. Lock Type | 5,920 Set |
| RDS 6224 | Rear Teeth (All Model) | 1,970 Each |
| RDS 6225 | Cross Holder Circlip Type 3516 | 2,160 Each |
| RDS 6226 | Half Yoke Circlip 3516 | 2,220 Each |
| RDS 6227 | Sleeve Yoke Circlip Type 3516 | 2,920 Each |
| RDS 6228 | Centre Coupling Flange | 2,095 Each |
| RDS 6229 | Diff. Coupling Flange | 2,010 Each |
| RDS 6230 | Gear Box Coupling Flange (6 Splines) |Each |
| RDS 6231 B | Front Teeth Leyland Taurus | 1,720 Each |
| RDS 6246 | Gear Box Coupling L/Taurus ZF (28 Splines) | 1,995 Each |

| Part No. | Description | LIST PRICE |
|--|---|------------|
| RDS 6121 | Sleeve Yoke Assy. (1 Yoke 1 Cross 1 Holder) EN 8 | 4,380 Set |
| RDS 6122 | Half Yoke Assy. L/L3" (1 Half Yoke 1 Cross, 1 Holder) | 3,900 Set |
| RDS 6123 | Half Yoke Assy. Leyland 3½" Base..... | 4,250 Set |
| RDS 6124 | Sleeve Yoke Leyland 370 | 1,890 Each |
| RDS 6125 | Rear Teeth Leyland 370 Full/Half Splines (3" Base) | 1,220 Each |
| RDS 6126 | Rear Teeth Leyland 370 Full/Half Splines (3½" Base) | 1,510 Each |
| RDS 6129 | Flange Yoke Cross Holder Leyland 370 | 1,445 Each |
| RDS 6130 | Half Yoke End Leyland (3" Base) | 1,430 Each |
| RDS 6131 | Half Yoke End Leyland (3½" Base) | 1,780 Each |
| RDS 6132 | Diff. Coupling Flange Leyland / Leyland Tasker | 1,345 Each |
| RDS 6133 | Centre Jhoola Coupling Flange Leyland (Key Type) | 1,170 Each |
| RDS 6134 | Gear Coupling Flange Leyland Plain Type (Square Base) | 995 Each |
| RDS 6134 A | Gear Coupling Flange Leyland Plain Type (Round Base) | 1,470 Each |
| RDS 6137 | Clutch Fork Leyland | Each |
| <div style="background-color: #0056b3; color: white; padding: 10px; display: inline-block; font-weight: bold; font-size: 1.2em;">LEYLAND CARGO</div> | | |
| RDS 6232 | Stub. Ball Half Yoke | 730 Each |
| RDS 6233 | Sleeve Yoke & Teeth Set | 2,390 Set |
| RDS 884 / 6233 A | Sleeve Yoke L/L Cargo / Canter N/M | 1,310 Each |
| RDS 6233 B | Rear Teeth L/L Cargo / Canter N/M | 1025 Each |
| RDS 6235 A | Cross Holder Leyland Cargo (XLO Type) Without Splines | 930 Each |
| | | |

| Part No. | Description | LIST PRICE |
|------------|---|------------|
| RDS 6162 | Sleeve Yoke Assy. Jeep Diesel (1 Yoke, 1 Cross, 1 Cross Holder)"..... | 1,945 Each |
| RDS 6162 A | Half Yoke Assy. Jeep Diesel (1 H. Yoke, 1 Cross, 1 Cross Holder)"..... | 1,690 Each |
| RDS 6163 | Flange Yoke Cross Holder Jeep/Diesel (Round Base)..... | 580 Each |
| RDS 6164 | Flange Yoke Cross Holder (Square Base)D/Jeep..... | 640 Each |
| RDS 6168 | Gear Coupling Jeep (Round)..... | 580 Each |
| RDS 6169 | Pinion Coupling Jeep W/.Dust Cap..... | 700 Each |
| RDS 6170 | Stub Ball Half Yoke End Jeep Diesel..... | 670 Each |
| RDS 6171 | Sleeve Yoke & Teeth Jeep Willys..... | Set |
| RDS 6172 | Sleeve Yoke & Teeth Jeep Diesel 7"..... | 1,635 Set |
| RDS 029 | Sleeve Yoke & Teeth Jeep Diesel 7" (TEFLON COATED) "..... | 1,830 Set |
| RDS 6172 A | Sleeve Yoke & Teeth Commander 6"..... | 1,595 Set |
| RDS 030 | Sleeve Yoke & Teeth Commander 6" (TEFLON COATED) "..... | 1,785 Set |
| RDS 6172 B | Sleeve Yoke & Teeth Jeep Utility (Teeth Head Size3")..... | 1,690 Set |
| RDS 6172 C | Half Yoke Utility Pick Up..... | 740 Each |
| RDS 6176 | Sleeve Yoke Jeep Diesel..... | 895 Each |
| RDS 6177 | Rear Teeth Jeep Diesel 7"..... | 730 Each |
| RDS 6177 A | Rear Teeth Commander 6"..... | 730 Each |
| RDS 027 | Cross Holder Mahindra Max..... | 640 Each |
| RDS 028 | Pinion Coupling Utility Pick Up (With Dust Cover) | 580 Each |
| RDS 031 | Sleeve Yoke & Teeth Jeep Utility (TEFLON COATED) | 1,910 Set |
| RDS 032 | Sleeve Yoke & Teeth MAXI TRUCK (TEFLON COATED) | 1,850 Set |
| RDS 571 | Sleeve Yoke & Teeth Mahindra Bolero DI / SLX (Flat Bed) (Jeep 6") (TEFLON COATED) (MSL Ref. No. 3220431 / 432) | 1,880 Set |
| RDS 572 | Sleeve Yoke & Teeth Mahindra Utility FC / NC (Jeep 7") (TEFLON COATED) (MSL Ref. No. 3220452 / 472) | 1,920 Set |
| RDS 573 | Sleeve Yoke & Teeth Mahindra Max Pickup (TEFLON COATED) (MSL Ref. No. 3220463 / 492) | 1,950 Set |
| RDS 574 | Sleeve Yoke & Teeth Mahindra Bolero DI / XYLO (Flat Bed) (TEFLON COATED) (MSL Ref. No. 3220469) | 2,060 Set |
| | | |

| Part No. | Description | LIST PRICE |
|-------------------|--|------------------|
| RDS 1755 | Centre Joint Coupling Eicher 11.10 (16 Splines) (Square Base) (Total Height 95 mm) (4 Holes) (Hole Dia 13 mm) (Bolt - 19 No.)..... | 1,460 Each |
| RDS 6250 | Cross Holder Canter O/M | 750 Each |
| RDS 6251 | Cross Holder Canter N/M | 840 Each |
| RDS 6252 | Half Yoke Canter O/M | Each |
| RDS 6253 | Half Yoke Canter N/M | 730 Each |
| RDS 6254 | Centre Coupling Canter (10 Splines) | 730 Each |
| RDS 6254 A | Differential Coupling Canter (14 Splines) | 730 Each |
| RDS 6254 B | Centre Coupling Canter (24 Splines) | 685 Each |
| RDS 6254 C | Front Teeth Canter N/M 10 Teeth (With Nut) | Each |
| RDS 6254 D | Diff. Coupling Flange Eicher Canter 10.90G (14 Splines) | 860 Each |
| RDS 6255 | Gear Coupling Canter | 970 Each |
| RDS 6256 | Yoke & Teeth Set Canter O/M | 2,350 Set |
| RDS 6256 A | Yoke & Teeth Canter N/M | 2,330 Set |
| RDS 6256 B | Yoke & Teeth Canter N/M (TEFLON COATED) | 2,330 Set |
| RDS 6258 | Cross Holder DCM N/M (Outer Side Lock) 14 B | Each |
| RDS 6258 A | Half Yoke DCM N/Model 14 B | |
| RDS 6258 B | Yoke and Teeth DCM N/M 14B | Set |
| RDS 6259 | Yoke & Teeth Swaraj Mazda | 2,390 Set |
| RDS 6260 | Cross Holder Swaraj Mazda (Round Base) | 850 Each |
| RDS 6260 A | Cross Holder Swaraj Mazda (Square Base) | 850 Each |
| RDS 6261 | Half Yoke Swaraj Mazda | 730 Each |
| RDS 6261 A | Diff. Coupling Swaraj Mazda (31 Spline) | 750 Each |
| RDS 6261 B | Center Coupling Swaraj Mazda (34 Spline) | 750 Each |
| RDS 6261 C | Front Teeth S/Mazda (34 Teeth) | Each |
| RDS 6270 | Center Joint Coupling D.C.M. Toyota | Each |
| RDS 6233 A | Sleeve Yoke L/L Cargo / Canter N/M | 1,365 Each |
| RDS 6233 B | Rear Teeth L/L Cargo / Canter N/M | 1025 Each |
| RDS 6271 | Differential Coupling Canter 11.10 (18 Splines) | 835 Each |
| | | |



RDS 218

Tata 3723, 4027, 3128 LPK
Bharat Benz 2523 C, Leyland 3123
(SPR 2045 / 2047, RSB 590 Series)
Cross Goli OD 52 mm
U.J. Cross Total Length 147 mm
List Price Rs.2,280



RDS 218 GL

Tata 3723, 4027, 3128 LPK
Bharat Benz 2523 C, Leyland 3123
(SPR 2045 / 2047, RSB 590 Series)
(Greaseless) Cross Goli OD 52 mm
U.J. Cross Total Length 147 mm
List Price Rs.2,520



RDS 220

AMW, MAN
Cross Goli OD 52 mm
U.J. Cross Total Length 133 mm
List Price Rs.2,160



RDS 6202 H

Tata 2515 / Leyland 2214, 2516
Eicher Galaxy 30.25 (Spicer Type)
Cross Goli OD 41.28 mm
U.J. Cross Total Length 126 mm
List Price Rs.1,215



RDS 906 GL

Tata 2515 / Leyland 2214, 2516
Eicher Galaxy 30.25 (Spicer Type)
(Greaseless) Cross Goli OD 41.28 mm
U.J. Cross Total Length 126 mm
List Price Rs.1,335



RDS 201

Tata 407 Pick Up / Tata 909
Eicher Pro 10.80 (MSL 1480 Series)
Cross Goli OD 34.95 mm
U.J. Cross Total Length 106 mm
List Price Rs.790



RDS 221 GL

Tata LPK 3138, 3128, Eicher 40T
(SPR 2060 Series) (Greaseless)
Cross Goli OD 59 mm
U.J. Cross Total Length 168 mm
List Price Rs.3,200



RDS 222

Leyland 3118 (RSB 585 Series)
Cross Goli OD 48 mm
U.J. Cross Total Length 154 mm
List Price Rs.1,820



RDS 222 GL

Leyland 3118 (RSB 585 Series)
(Greaseless) Cross Goli OD 48 mm
U.J. Cross Total Length 154 mm
List Price Rs.2,000



RDS 117

Tata 2515 Ex (RSB 325 Series)
Cross Goli OD 42 mm
U.J. Cross Total Length 119 mm
List Price Rs.1,215



RDS 121 M

Tata 2515 / 1613 Turbo (RSB 403 Series)
Cross Goli OD 42 mm
U.J. Cross Total Length 129.35 mm
List Price Rs.1,310



RDS 601

Tata 4018 / 3118 Patti Type (Spicer Model)
AMW 2518, Mahindra Navistar
U.J. Cross Goli OD 49.2 mm
U.J. Cross Total Length 135 mm
List Price Rs.2,040



RDS 111

Tata 4018 / 3118 Lock Type (RSB 490 Series)
Cross Goli OD 48 mm
U.J. Cross Total Length 135 mm
List Price Rs.1,525



RDS 111 GL

Tata 4018 / 3118 Lock Type (RSB 490 Series)
(Greaseless) Cross Goli OD 48 mm
U.J. Cross Total Length 135 mm
List Price Rs.1,660



RDS 216

AMW
(Cross Goli OD 57 mm)
U.J. Cross Total Length 144 mm
List Price Rs.2,440



RDS 6202 G

Tata 4928, 2528, Bharat Benz 2528
(SPR 2040 Series)
Leyland Taurus 3516 (Circlip Type)
Cross Goli OD 47.65 mm
U.J. Cross Total Length 135 mm
List Price Rs.1,470



RDS 907 GL

Tata 4928, 2528, Bharat Benz 2528
(SPR 2040 Series) **(Greaseless)**
Leyland Taurus 3516 (Circlip Type)
Cross Goli OD 47.65 mm
U.J. Cross Total Length 135 mm
List Price Rs.1,640



RDS 219

Tata 4923
(SPR 2055, RSB 620 Series)
Cross Goli OD 57 mm
U.J. Cross Total Length 152 mm
List Price Rs.2,440



RDS 6201

Tata 1210 / 608 / 807 / 407 N/M Rear

Size : 38.05 mm

List Price Rs.790



RDS 905 GL

Tata 1210 / 608 (Greaseless)

Size : 38.05 mm

List Price Rs.915



RDS 6201 A

Tata 1312 / 1612

Size : 46.05 mm x 118 mm

List Price Rs.1,215



RDS 6201 A GL

Tata 1312 / 1612 (Greaseless)

Size : 46.05 mm x 118 mm

List Price Rs.1,335



RDS 6201 BT

Tata 407 Turbo (Rear)
with Straps & Bolt

Size : 30.18 mm x 106 mm

List Price Rs.745



RDS 6201 E

Tata Steering 92 Model /1312

Size : 19 mm x 42 mm

List Price Rs.325



RDS 6202

Bedford Leyland 370

Size : 39.70 mm x 116 mm

List Price Rs.880



RDS 6202 B

Leyland Taskar (MSL Type), L/L Hino
Tata 909 Ex BS III, Eicher Jumbo 20.15

Size : 34.95 mm x 126 mm

List Price Rs.880



RDS 6202 B GL

Leyland Taskar (MSL Type),
L/L Hino (Greaseless)

Size : 34.95 mm x 126 mm

List Price Rs.1,030



RDS 6213

Maruti Gypsy / Tata ACE Mega
Size : 25 mm x 63.75 mm
List Price Rs.425



RDS 6213 A

Maruti Van O/M, Eeco
(Inner Side Lock)
Goli Size 25 mm
List Price Rs.425



RDS 6214

Ambassador / Omni
(Outer Side Lock) / Leyland Steering
Size : 23.83 mm x 61 mm
List Price Rs.390



RDS 036

Tata ACE O/M
(Inner Side Lock)
Goli Size : 23.83 mm
List Price Rs.405



RDS 6201 BS

Tata Sumo N/M, Force Guster
(Spicer Design W / Patti & Bolt)
Size : 27 mm x 82 mm
List Price Rs.535



RDS 036 B

Tata Super ACE
Size : 23.83 mm x 59 mm
List Price Rs.405



RDS 036 A

Tata ACE N/M (Magic)
(Outer Side Lock)
Size : 22 mm x 54.85 mm
List Price Rs.385



RDS 036 C

Tata ACE (Mint)
Size : 26 mm x 82 mm
List Price Rs.445



RDS 6212

Tata 407 Turbo (MSL Type) / Mahindra XYLO
DCM N/M (14 B), Allwyn Nissan / Tempo Traveller
Size : 30.18 mm x 92 mm
List Price Rs.575



RDS 6210 A

Jeep Diesel / Leyland Dost
Mahindra Marshal, Bolero, Commander
Size : 27 mm x 82 mm
List Price Rs.405



RDS 6210 A GL

Jeep Diesel (Greaseless)
Size : 27 mm x 82 mm
List Price Rs.500



RDS 6210 B

Mahindra Scorpio (Greaseless)
Marshal, Bolero / Leyland Dost
Size : 27 mm x 82 mm
List Price Rs.450



RDS 6211

Jeep Front Axle
Size : 27 mm
List Price Rs.475



RDS 6217 A

Mahindra Champion
(With Four Cross Goli)
Size : 27 mm
List Price Rs.425



RDS 6218 A

Toyota Qualis
Size : 29 mm
List Price Rs.490



RDS 908

U.J Cross Tavera (Greaseless)
Size : 29 mm
List Price Rs.490



RDS 6210 C

Mahindra Maxximo
Size : 27 mm x 82 mm
List Price Rs.535



RDS 6201 B

Tata 407/ Tata Estate / Siera/ Sumo /
mobile 206
Size : 30.04 mm x 82 mm
List Price Rs.515



RDS 6201 B GL

Tata 407 / Tata Estate / Siera
Sumo O/M (Greaseless)
Size : 30.04 mm x 82 mm
List Price Rs.625



RDS 6201 C

Tata Steering 407/608
Size : 18 mm x 42 mm
List Price Rs.310



RDS 6208

Tata 407 Turbo Ex (Spicer Design)
Eicher Canter (10.60, 10.75, 10.90)
Swaraj Mazda, L/L Cargo,
L/L Iveco (709, 909) Mahindra CAB King
Size : 30.18 mm x 106 mm
List Price Rs.650



RDS 6216 D

Tempo Trax N/M
(With Nipple on Cross Goli) /
Bajaj Minidor / Mahindra Force
Size : 30 mm x 82 mm
List Price Rs.450



RDS 119

U.J Cross Canter N/M /Mazda
(With Extra Long Cross Goli's
as per O.E. Design
Size : 30.18 mm x 106 mm
List Price Rs.740

*Many
more to
come*



RDS 6051

Tata 3015/1612 TC (16 Teeth)
List Price Rs.1,690

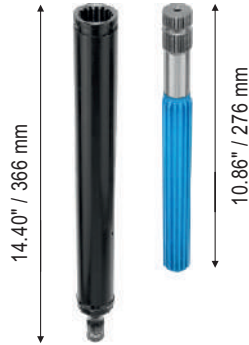

RDS 6051 T

Tata 3015/1612 TC (16 Teeth)
Teflon Coated
List Price Rs.1,940



RDS 6052

Tata 2515 (Rane Type) (16 Teeth)
List Price Rs.1,850



RDS 6052 T

Tata 2515 (Rane Type) (16 Teeth)
Teflon Coated
List Price Rs.2,005



RDS 6053

Tata 2515 ZF
List Price Rs.1,850



RDS 6053 T

Tata 2515 (ZF Type)
Teflon Coated
List Price Rs.2,005



RDS 139

Tata 1613 SFC
List Price Rs.1,380



RDS 139 T

Tata 1613 SFC
Teflon Coated
List Price Rs.2,035

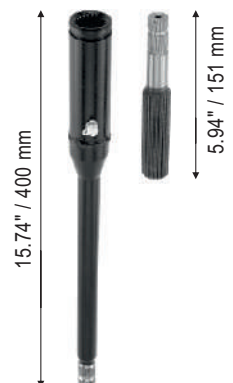

RDS 6072

Tata 407 N/M with Grease Nipple
List Price Rs.1,075



RDS 137
Tata 407 **Teflon Coated**
List Price Rs.1,380

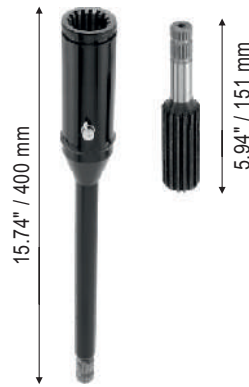

RDS 6072 A
Tata 407 N/M Heavy Duty with Grease Nipple
List Price Rs.1,165

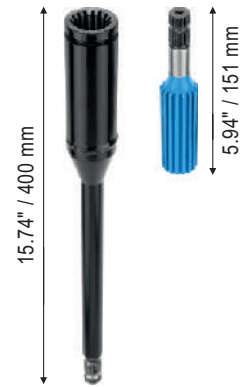

RDS 6072 AT
Tata 407 N/M Heavy Duty
Teflon Coated
List Price Rs.1,525

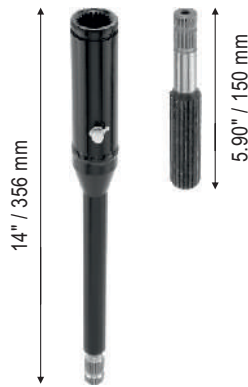

RDS 6073
Tata 609 with Grease Nipple
List Price Rs.1,075

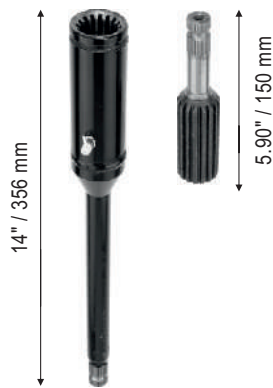

RDS 6073 A
Tata 609 Heavy Duty with Grease Nipple
List Price Rs.1,165

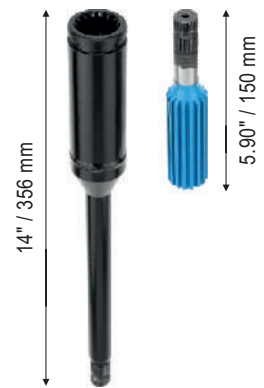

RDS 6073 AT
Tata 609 Heavy Duty with Grease Nipple
Teflon Coated
List Price Rs.....



RDS 6074
Tata 709 with Grease Nipple
List Price Rs.1,165



RDS 6074 T
Tata 709 **Teflon Coated**
List Price Rs.1,525



RDS 138
Tata 1109 LPT (16 Teeth)
List Price Rs.1,380



RDS 501

Tata 1109 N/M (16 Teeth)
List Price Rs.1,415



RDS 501 T

Tata 1109 N/M (16 Teeth)
Teflon Coated
List Price Rs.1,875



RDS 502

Tata 709/712/1109 Bus (Rane Type)
List Price Rs.985

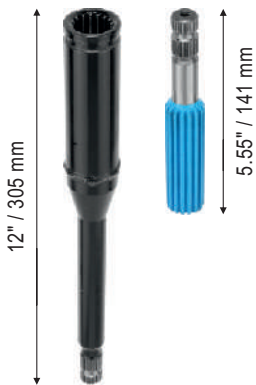

RDS 502 T

Tata 709/712/1109 Bus (Rane Type)
Teflon Coated
List Price Rs.1,315



RDS 503

Tata 909 (16 Teeth)
List Price Rs.1,165

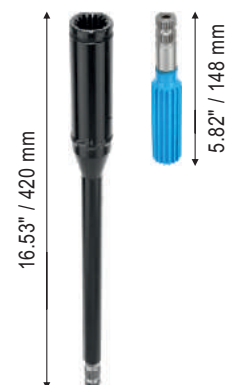

RDS 503 T

Tata 909 (16 Teeth)
Teflon Coated
List Price Rs.



RDS 504

Tata 4018
List Price Rs.1,440

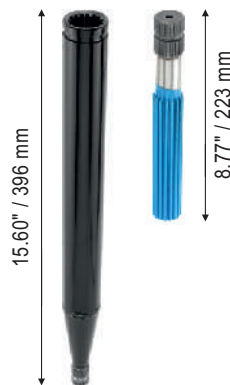

RDS 504 T

Tata 4018 **Teflon Coated**
List Price Rs.1,970



RDS 909

Tata 1613 LPT (Total Length 12")
List Price Rs.1,200



RDS 504 A
Tata 4018 N/M
List Price Rs.2,005

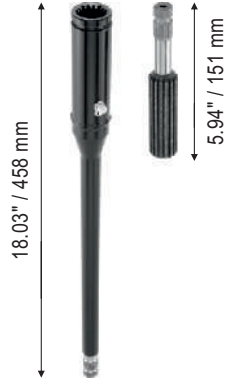

RDS 508
Tata 410
List Price Rs.1,120



RDS 505
Tata 1613 BS-III
List Price Rs.1,430



RDS 505 T
Tata 1613 BS-III **Teflon Coated**
List Price Rs.1,880



RDS 506
Tata 1109 BS-III
List Price Rs.1,440



RDS 507
Tata 4923
List Price Rs.1,360



RDS 507 T
Tata 4923 **Teflon Coated**
List Price Rs.1,820



KEEPS YOU SMILING



RDS 162
Gear Cross Assy. Tata 1512/1613 TC



RDS 163
Gear Cross Assy. Tata 2516 TC



RDS 164
Gear Cross Assy. Tata 2515 Ex



RDS 165
Gear Cross Assy. Tata 4018



RDS 166
Gear Cross Assy. Leyland



RDS 167
Gear Cross Assy. Tata 1616

| Part No. | Description | LIST PRICE |
|-----------------------------------|--|----------------|
| RDS 6018 | Steering Cross Assy. 1210 | ₹ 1,065/- Each |
| RDS 6019 | Stg. Cross Assy. Tata & Leyland ZF Steering | ₹ 1,065/- Each |
| RDS 6048 | Steering Assy. Tata 92 Model / 1312 | ₹ 955/- Each |
| RDS 6049 | Steering Assy. Tata 2213 | ₹ 980/- Each |
| RDS 6050 | Steering Cross Assy. 1613 Turbo | ₹ 970/- Each |
| RDS 6070 | Steering Cross Assy. (2 St. Yoke, 1 Cross) 407 With Genuine Nut Bolt | ₹ 710/- Each |
| RDS 6070 A | Steering Cross Assy. - Tata 407 (Telco Type Sealing) | ₹ 710/- Each |
| RDS 6070 B | Steering Cross Assy. - Tata 1109 | ₹ 715/- Each |
| RDS 040 | Steering Cross Ass. ACE | ₹ 630/- Each |
| RDS 6136 | Steering Cross Assy. Leyland Thin/Thick Splines | ₹ 960/- Each |
| RDS 6138 | Steering Cross Assy. L/L ZF (Power Stg.) | ₹ 1,065/- Each |
| RDS 6138 A | Steering Cross Assy. L/L Extra Long Thick Splines | ₹ 1,085/- Each |
| RDS 6138 B | Steering Cross Assy. L/L Extra Long Thin Splines | ₹ 1,085/- Each |
| RDS 6138 C | Steering Cross Assembly Leyland ZF Stg. (Both Side Small Yoke) | ₹ 980/- Each |
| RDS 6182 | Stg. Cross Assy. Armada | ₹ 735/- Each |
| RDS 6183 | Stg. Cross Assy. Commander / Marshall | ₹ 735/- Each |
| RDS 6266 | Steering Cross Assembly Canter N/M (16 Splines / 18 Splines) | ₹ 1,055/- Each |
| RDS 6266 A | Steering Cross Assembly Canter 11.10 Latest | ₹ 1,175/- Each |
| RDS 6267 | Steering Cross Assembly Swaraj Mazda O/M (12 Splines) | ₹ 1,055/- Each |
| RDS 6268 | Steering Cross Assembly Swaraj Mazda N/M (16 Splines) | ₹ 1,055/- Each |
| RDS 6269 | Steering Cross Assembly DCM Toyota | ₹ 1,030/- Each |
| RDS 6272 | Steering Cross Assembly Canter 10.95 (Extra long) | ₹ 1,380/- Each |
| RDS 6048 A | Steering Cross Assembly 1312/TATA 92 Model (O.E Seal Type) | ₹ 955/- Each |
| RDS 6049 A | Steering Cross Assembly 2213 (O.E Seal Type) | ₹ 980/- Each |
| RDS 6050 A | Steering Cross Assembly 1613 Turbo (O.E Seal Type) | ₹ 970/- Each |
| GEAR CROSS ASSY. (JHAMELA) | | |
| RDS 162 | Gear Cross Assy. Tata 1512 / 1613 TC | ₹ 1,395/- Each |
| RDS 163 | Gear Cross Assy. Tata 2516 TC | ₹ 1,395/- Each |
| RDS 164 | Gear Cross Assy. Tata 2515 Ex | ₹ 1,395/- Each |
| RDS 165 | Gear Cross Assy. Tata 4018 | ₹ 1,105/- Each |
| RDS 166 | Gear Cross Assy. Leyland | ₹ 1,495/- Each |
| RDS 167 | Gear Cross Assy. Tata 1616 TC | ₹ 1,435/- Each |



RDS 1801
Tata 2416 (Bush Type)
(with 6211 Bearing, ID 55 mm)
List Price : Rs.1,040



RDS 1802
Tata 2416 (Bush Type)
(with 6211 - 2RS Bearing ID 55 mm)
List Price : Rs.1,040



RDS 1803
Tata 2518 (Bush Type)
(with 6013 Bearing, ID 65 mm)
List Price : Rs.1,040



RDS 1804
Tata 2518 (Bush Type)
(with 6013 - 2RS Bearing, ID 65 mm)
List Price : Rs.1,080



RDS 1805
Leyland 2516 / 2214
(with 88509 - 2RS Bearing, ID 45 mm)
List Price : Rs. 946



RDS 1806
Tata 3118 O/M (for Spicer Shaft)
(with 6012 - 2RS Bearing, ID 60 mm)
List Price : Rs.1,070



RDS 1807
Tata 4018 TC (with Big Collar Cup)
(with 6211 - 2RS Bearing, ID 55 mm)
List Price : Rs.990



RDS 1808
Tata 4018 TC (with Small Collar Cup)
(with 6211 - 2RS Bearing, ID 55 mm)
List Price : Rs.990



RDS 1809
Eicher Canter 10.90, 10.95, 11.10
(with 7240 - 2RS Bearing, ID 40 mm)
List Price : Rs.950



RDS 1810
Tata 1312 / 92 Model
(with 6208 - 2RS Bearing, ID 40 mm)
List Price : Rs.845



RDS 1811
Tata 407 (with 2 Collar Rubber)
(with 6207 - 2RS Bearing, ID 35 mm)
List Price : Rs.670



RDS 1812
Tata 407 (with 3 Collar Rubber)
(with 6207 - 2RS Bearing, ID 35 mm)
List Price : Rs.670



RDS 1813
Mahindra XYLO
(with 6006 - 2RS Bearing, ID 30 mm)
List Price : Rs.1,130



RDS 1814
Tempo Trax / Traveller
(with 6009 - 2RS Bearing, ID 45 mm)
List Price : Rs.950



RDS 1815
Tata 4018 / Leyland 3516
(with 6212 - 2RS Bearing, ID 60 mm)
List Price : Rs.....



RDS 1816
Tata 2515 EX (with 3 Collar Rubber)
(with 88511 Bearing, ID 55 mm)
List Price : Rs.1,045



RDS 1817
Tata 2515 / 2518 (with 3 Collar Rubber)
(with 62211 - 2RS Bearing, ID 55 mm)
List Price : Rs.1,300



RDS 1818
Tata 407 / 608 (with 2 Collar Rubber)
(with 88507 - 2RS Bearing, ID 35 mm)
List Price : Rs.660



RDS 1819
Tata 407 / 608 (with 3 Collar Rubber)
(with 88507 - 2RS Bearing, ID 35 mm)
List Price : Rs.660



RDS 1820
Mahindra Scorpio, Bolero O/M
(with 88507 - 2RS Bearing, ID 35 mm)
List Price : Rs.1,165



RDS 1821
Mahindra Scorpio, Bolero N/M
(with 88507 - 2RS Bearing, ID 35 mm)
List Price : Rs.680



RDS 1822
Mahindra Bolero N/M (with Clamp)
(with 88507 - 2RS Bearing, ID 35 mm)
List Price : Rs.860



RDS 1824
Swaraj Mazda
(with 6007 - 2RS Bearing, ID 35 mm)
List Price : Rs.760



RDS 1825
Tata 709 / 909 / 1109 Turbo
(with 88508 - 2RS Bearing, ID 40 mm)
List Price : Rs.790



RDS 1826
Tata Hywa, 1616 N/M
(with 6015 - 2RS Bearing, ID 75 mm)
List Price : Rs.1,520



RDS 1827
Tata 3118 (RSB Shaft) (Cut Type)
(with 6211 - 2RS Bearing, ID 55 mm)
List Price : Rs.1,230



RDS 1827 R
Tata 3118 (RSB Shaft) (Round Rubber)
(with 6211 - 2RS Bearing, ID 55 mm)
List Price : Rs.1,230



RDS 1828
Tempo Traveller / CRUISER
(with 6207 - 2RS Bearing, ID 35 mm)
List Price : Rs.730



RDS 1829
Eicher Jumbo (with 3 Bolts & Bracket)
(with 6011 - 2RS Bearing, ID 55 mm)
List Price : Rs.1,490



RDS 1830
Tata 3118 (with Big Rubber)
(with 6013 - 2RS Bearing, ID 65 mm)
List Price : Rs.990



RDS 1841
Tata 410 EX
(with 6010 - 2RS Bearing, ID 50 mm)
List Price : Rs.730



RDS 1842
Tata 3718 / Bharat Benz
(with 6011 - 2RS Bearing, ID 55 mm)
List Price : Rs.980



RDS 1843
Eicher Jumbo (without Bolts & Bracket)
(with 6011 - 2RS Bearing, ID 55 mm)
List Price : Rs.830



RDS 1844
Tata / Leyland 4018
(with 88512 - 2RS Bearing, ID 60 mm)
List Price : Rs.1,450



RDS 1845
Tata 3118 (RSB Shaft, Round Rubber)
(with 6013 - 2RS Bearing, ID 65 mm)
List Price : Rs.1,380



RDS 1846
Tata 407 / 709 (with Bracket)
(with 6207 - 2RS Bearing, ID 35 mm)
List Price : Rs.900



RDS 1847
Tata 3718 Latest
(with 88514 - 2RS Bearing, ID 70 mm)
List Price : Rs.1,440



RDS 1848 (88512 MOD.)
Tata / Leyland 4018
(with 88512 - 2RS Bearing, ID 60 mm)
List Price : Rs.1,490



RDS 1849
Eicher Jumbo (with 3 Bolts)
(with 6011 - 2RS Bearing, ID 55 mm)
List Price : Rs.1,010



RDS 1850
Tata Hywa (Tipper Model)
(Plain Rubber, without Collar)
(with 6211 - 2RS Bearing, ID 55 mm)
List Price : Rs.1,070



RDS 1851
Tata 3728 (Big Rubber)
(with 6211 - 2RS Bearing, ID 55 mm)
List Price : Rs.1,150



RDS 1852
Leyland BS VI
(with 6211 - 2RS Bearing, ID 55 mm)
List Price : Rs.1,070



RDS 1853
Leyland / Tata 3718 / Bharat Benz
(with 6011 - 2RS Bearing, ID 55 mm)
(22 mm thick cone) **List Price : Rs.1,110**



RDS 431
Leyland 2214 / 3516
(with 88509 - 2RS Bearing, ID 45 mm)
List Price : Rs.1,360



RDS 432
Tata 2416 / 1510 (Bush Type)
(with 6211 - 2RS Bearing, ID 55 mm)
List Price : Rs.1,850



RDS 433
Tata 3118 O/M (for Spicer Shaft)
(with 6012 - 2RS Bearing, ID 60 mm)
List Price : Rs.1,920



RDS 434
Tata 2518 (Bush Type - RSB Shaft)
(with 6013 - 2RS Bearing, ID 65 mm)
List Price : Rs.1,850



RDS 435
Tata 3118 (Round Rubber) (RSB Shaft)
(with 6211 - 2RS Bearing, ID 55 mm)
List Price : Rs.2,280



RDS 436
Tata / Leyland 4018 (MSL Type)
(with 88512 - 2RS Bearing, ID 60 mm)
List Price : Rs.2,510



RDS 437
Eicher Canter 10.60 / 10.95
(with 7240 - 2RS Bearing, ID 40 mm)
List Price : Rs.1,390

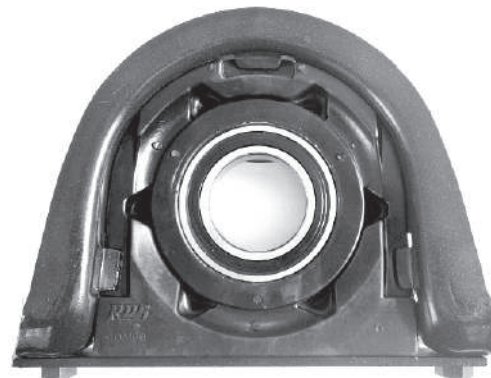

RDS 438
Tata 3718 / Bharat Benz 2523
(with 6011 - 2RS Bearing, ID 55 mm)
List Price : Rs.2,260



RDS 831
Leyland 2214 / 3516
(Suitable for 88509 WOS Bearing)
List Price : Rs.260



RDS 832
Tata 2416 (Bush Type)
(Suitable for 6211 Bearing)
List Price : Rs.440



RDS 833
Tata 3118 O/M (Spicer Type)
(Suitable for 6012 Bearing)
List Price : Rs.520



RDS 834
Tata 2518 (Bush Type)
(Suitable for 6013 Bearing)
List Price : Rs.440



RDS 835
Tata 1312 / 1510 / 92 Model
(Suitable for 6208 WOS Bearing)
List Price : Rs.260



RDS 836
Tata 4018 TC
(Suitable for 6211 WOS Bearing)
List Price : Rs.250



RDS 837
Mahindra Scorpio / Bolero
(Suitable for 88507 WOS Bearing)
List Price : Rs.250



RDS 838
Tata 709 / 909 / 1109 Turbo
(Suitable for 88508 WOS Bearing)
List Price : Rs.240



RDS 839
Tata 3118 Cut Type (RSB Type)
(Suitable for 6211 Bearing)
List Price : Rs.620



RDS 840
Tata 3118 (RSB Type) (Round)
(Suitable for 6211 Bearing)
List Price : Rs.620



RDS 851
Tata 407 (2 Collars)
(Suitable for 6207 WOS Bearing)
List Price : Rs.230



RDS 852
Tata / Leyland 4018 (MSL Type)
(Suitable for 88512 Bearing)
List Price : Rs.540



RDS 853
Tata 3718 / Bharat Benz
(Suitable for 6011 Bearing)
List Price : Rs.520



RDS 854
Eicher Canter 10.40 / 10.60 / 10.90
(Suitable for 7240 WOS Bearing)
List Price : Rs.290



RDS 855
Swaraj Mazda
(Suitable for 6007 WOS Bearing)
List Price : Rs.200



RDS EM 301
Front Eng. Mtg.
Tata 1312 / 1612 / 2416 (16 mm)
List Price : Rs.620



RDS EM 302
Front Eng. Mtg.
Tata 1312 / 1612 / 2416 (14 mm)
List Price : Rs.620



RDS EM 303
Rear Eng. Mtg.
Tata 2515 TC (4 Bolts)
List Price : Rs.600



RDS EM 304
Front Eng. Mtg.
Tata 1210 / SE
List Price : Rs.860



RDS EM 305
Rear Eng. Mtg.
Tata 1210 / SE
List Price : Rs.930



RDS EM 306
Front Eng. Mtg.
Tata 407 (LEFT)
List Price : Rs.510



RDS EM 307
Front Eng. Mtg.
Tata 407 (RIGHT)
List Price : Rs.510



RDS EM 308
Front Eng. Mtg.
AMW (Heavy Duty)
List Price : Rs.540



RDS EM 309
Front Eng. Mtg.
Eicher Canter 10.60 / 10.95
List Price : Rs.500



RDS EM 310
Rear Eng. Mtg.
Euro III (LEFT)
List Price : Rs.900



RDS EM 311
Rear Eng. Mtg.
Euro III (RIGHT)
List Price : Rs.900



RDS EM 312
Front Eng. Pad
Leyland Taskar (H / Duty)
List Price : Rs.280



RDS EM 313
Gear Box Mtg.
Leyland (Metacone Type)
List Price : Rs.480



RDS EM 314
Rear / Gear Box Mtg.
Tata 407 (Heavy Duty)
List Price : Rs.310

RDS EM 315
Front Eng. Mtg.
Sumo Spacio (LEFT)
List Price : Rs.....



RDS EM 317
Front Eng. Mtg.
Tata 709 (LEFT)
List Price : Rs.600



RDS EM 318
Front Eng. Mtg.
Tata 709 (RIGHT)
List Price : Rs.600

RDS EM 319
Front Eng. Mtg.
Tata ACE (H / Duty)
List Price : Rs.....



RDS EM 320
Gear Box Mtg.
Tata ACE (Heavy Duty)
List Price : Rs.670



RDS EM 321
Gear Box Mtg.
Metacone / AMW (Double Plate)
List Price : Rs.530



RDS EM 322
Front Eng. Mtg.
Eicher JUMBO
List Price : Rs.680



RDS EM 323
Gear Box Mtg.
Eicher JUMBO
List Price : Rs.1,120



RDS EM 324
Rear Eng. Mtg.
Tata 1613 TC / Euro II (LEFT)
List Price : Rs.900



RDS EM 325
Rear Eng. Mtg.
Tata 1613 TC / Euro II (RIGHT)
List Price : Rs.900

RDS EM 326
Rear / Gear Box Mtg.
Tata 608 / 709 (H / Duty)
List Price : Rs.825



RDS EM 327
Front Eng. Mtg.
Leyland U Truck
List Price : Rs.680



RDS EM 328
Front Eng. Mtg.
L/L U Truck (with Housing)
List Price : Rs.1,030



RDS EM 329
Rear Eng. Mtg.
Tata 3718 (BS IV)
List Price : Rs.1,980



RDS EM 345
Rear Eng. Mtg.
Tata 3718 (BS VI)
List Price : Rs.1,980



RDS EM 330
Rear Eng. Mtg.
Tata 1312 (LEFT)
List Price : Rs.980



RDS EM 331
Rear Eng. Mtg.
Tata 1312 (RIGHT)
List Price : Rs.980



RDS EM 332
Rear Eng. Mtg.
Tata PRIMA (H / Duty)
List Price : Rs.995

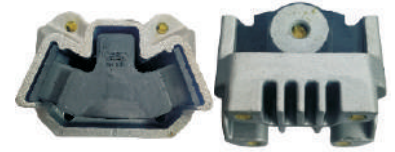

RDS EM 333
Gear Box Mtg.
Bharat Benz (H / Duty)
List Price : Rs.3,600



RDS EM 334
Front Eng. Mtg.
Leyland BS IV (LEFT)
List Price : Rs.1,060



RDS EM 335
Front Eng. Mtg.
Leyland BS IV (RIGHT)
List Price : Rs.1,060



RDS EM 336
Front Eng. Mtg.
Bharat Benz (LEFT)
List Price : Rs.3,780



RDS EM 337
Front Eng. Mtg.
Bharat Benz (RIGHT)
List Price : Rs.3,780



RDS EM 338
Rear Eng. Mtg.
Tata 909 / 1109 / 407 BS IV
List Price : Rs.640

RDS EM 339
Front Eng. Mtg.
Eicher 11.14 XP (LEFT)
List Price : Rs.

RDS EM 340
Front Eng. Mtg.
Eicher 11.14 XP (RIGHT)
List Price : Rs.

RDS EM 341
Front Eng. Mtg.
Tata Ultra (LEFT)
List Price : Rs.1,190

RDS EM 342
Front Eng. Mtg.
Tata Ultra (RIGHT)
List Price : Rs.1,190



RDS EM 841
Front Eng. Mtg.
Marshall / Bolero / Armada
List Price : Rs.378



RDS EM 842
Gear Box Mtg.
Marshall / Utility / Armada
List Price : Rs.465



RDS EM 843
Gear Box Mtg.
Bolero Pickup / Max Turbo
List Price : Rs.465



RDS EM 844
Front Engine Mounting
Eicher PRO (Heavy Duty)
List Price : Rs.1,010



RDS EM 845
Gear Box Mtg. (Universal - with 8 Holes)
Marshall / Bolero Pickup / Max Turbo
List Price : Rs.530



RDS EM 846
Front Engine Mounting
Tata 1109 BS IV (12 mm Thread)
List Price : Rs.710



RDS EM 847
Front Engine Mounting
Tata 1109 BS IV (14 mm Thread)
List Price : Rs.710



RDS EM 346
Rear Engine Mounting
Leyland E Comet (Heavy Duty)
List Price : Rs.730



RDS EM 848
Gear Box Mounting (Heavy Duty)
Bharat Benz Trailer (BS-VI)
List Price Rs.4,200 Each



RDS EM 849
Front Engine Mounting
Tata 1512 Ultra (LEFT) (With H/Duty Bracket)
List Price Rs.2,490 Each



RDS EM 850
Front Engine Mounting
Tata 1512 Ultra (RIGHT) (With H/Duty Bracket)
List Price Rs.2,490 Each



RDS EM 344
Gear Box Mounting LEYLAND DOST
(Heavy Duty)
List Price Rs.770 Each



RDS 286
Cabin Mounting Bharat Benz (LEFT)
(With Heavy Duty Bracket)
List Price Rs.910 Each



RDS 287
Cabin Mounting Bharat Benz (RIGHT)
(With Heavy Duty Bracket)
List Price Rs.910 Each



RDS HP 101

Tata 2518, 2523 Tippers
(Round Shape)
(2 Holes x 4 Holes)
List Price Rs.3,450

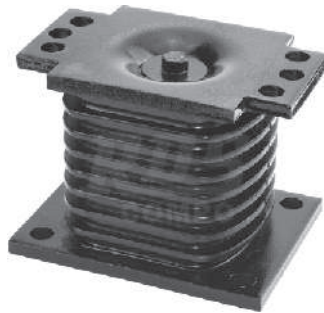

RDS HP 102

Volvo Trucks
(Rectangular Shape)
(6 Holes x 4 Holes)
List Price Rs.3,650



RDS HP 107

Hollow Pad Hywa N/M
(Rectangular) (With 6 Holes)
(Middle Hole OVAL Shape)
List Price Rs.3,580

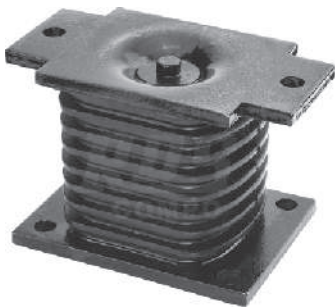

RDS HP 103

Tata Tipper 2528 Trucks
(Rectangular Shape)
(2 Holes x 4 Holes)
List Price Rs.3,580



RDS HP 104

Tata Tipper 2528 Trucks
(Rectangular Shape) (Oval Holes)
(2 Holes x 4 Holes)
List Price Rs.3,650



RDS HP 105

Eicher Trucks O/M
(Round Shape)
(2 Holes x 4 Holes)
List Price Rs.3,830



RDS HP 106

Hollow Pad Eicher N/M
(Same shape as OE)
List Price Rs.3,990



RDS HP 108

Mercedes Actros (5 Plates)
List Price Rs.



RDS HP 109

Mercedes Actros (7 Plates)
List Price Rs.

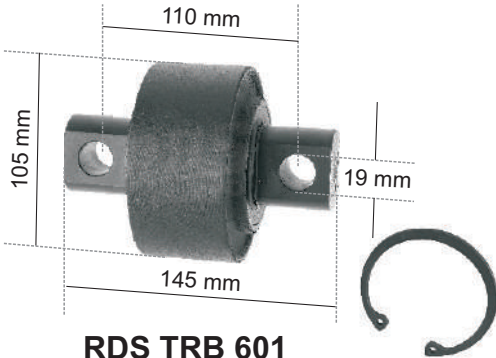

RDS TRB 601

Torque Rod Bush AMW O/M 2518, 2523 Tipper
Rotational Type (105 mm OD) (With Circlips)
(Hole Dia 19 mm Round) (Hole to Hole Distance 110 mm)
(Total Length 145 mm) **List Price : Rs.1,740**



RDS TRB 602

Torque Rod Bush **AMW N/M** 2518, 2523 Tipper
(87 mm OD) (With Circlips) (Hole Dia 19 mm Round)
(Hole to Hole Distance 110 mm) (Total Length 148 mm)
List Price : Rs.1,572

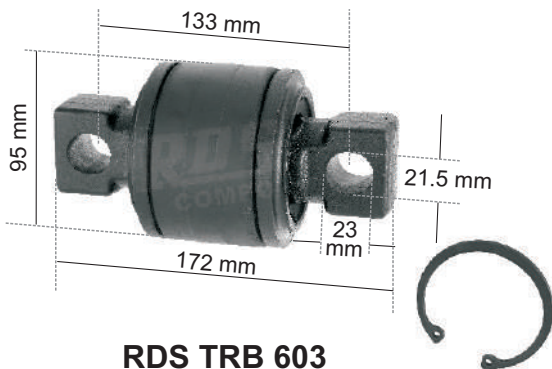

RDS TRB 603

Torque Rod Bush Tata 2518, 2523
(95 mm OD) (With Circlips) (Hole Dia 21.5 mm x 23 mm Oval)
(Hole to Hole Distance 133 mm) (Total Length 172 mm)
List Price : Rs.1,968

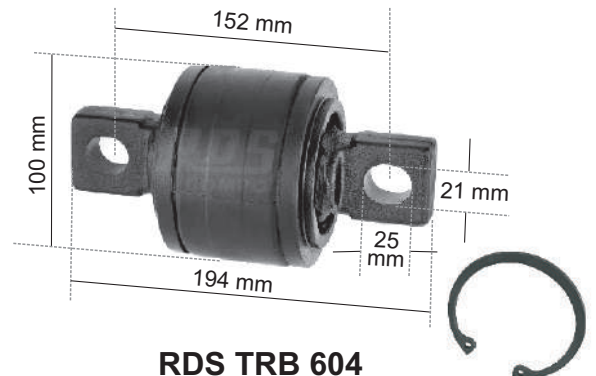

RDS TRB 604

V Rod / Torque Rod Bush Tata Prima 4923, 2523
(100 mm OD) (With Circlips) (Hole Dia 21 mm x 25 mm OVAL)
(Hole to Hole Distance 152 mm) (Total Length 194 mm)
List Price : Rs.2,640

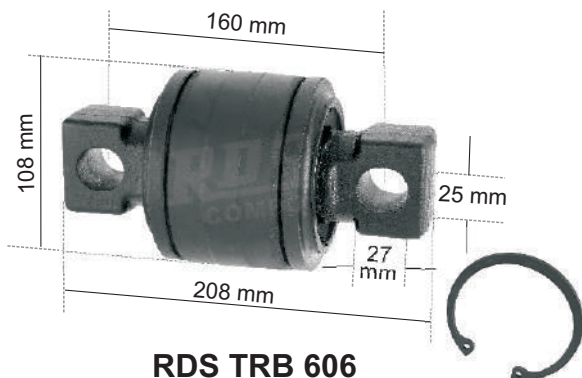

RDS TRB 606

V Rod Bush Tata 2518, 2523 Tipper / Tata Prima
(108 mm OD) (With Circlips) (Hole Dia 25 mm x 27 mm OVAL)
(Hole to Hole Distance 160 mm) (Total Length 208 mm)
List Price : Rs.2,940



RDS TRB 607

Torque Rod Bush Leyland U Truck
(85 mm OD) (With Circlips) (Hole Dia 19 mm Round)
(Hole to Hole Distance 130 mm) (Total Length 168 mm)
List Price : Rs.1,644

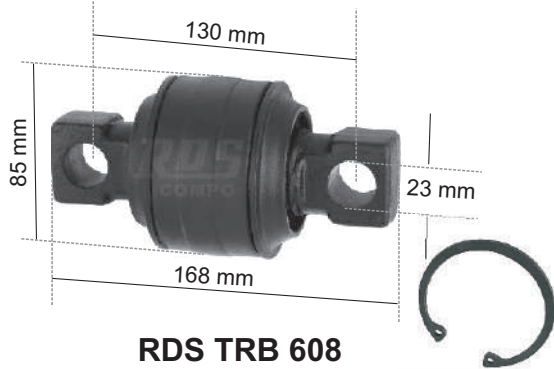

RDS TRB 608

Torque Rod Bush Bharat Benz (with Short Rod)
 (85 mm OD) (With Circlips) (Hole Dia 23 mm Round)
 (Hole to Hole Distance 130 mm) (Total Length 168 mm)

List Price : Rs.1,725

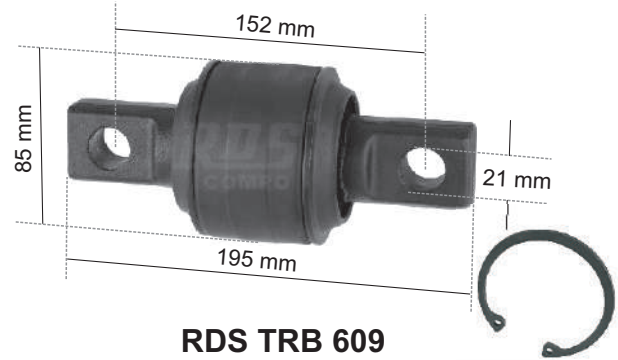

RDS TRB 609

Torque Rod Bush Bharat Benz (with Long Rod)
 (85 mm OD) (With Circlips) (Hole Dia 21 mm Round)
 (Hole to Hole Distance 152 mm) (Total Length 195 mm)

List Price : Rs.1,670

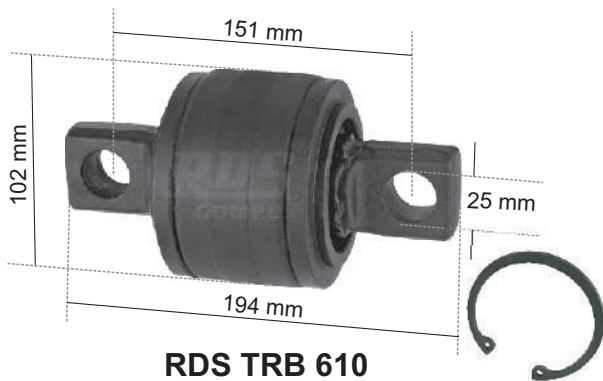

RDS TRB 610

V Rod Bush Bharat Benz / Leyland U Truck
 (102 mm OD) (With Circlips) (Hole Dia 25 mm Round)
 (Hole to Hole Distance 151 mm) (Total Length 194 mm)

List Price Rs.2,450



RDS CP 611

V Stay Centre Bush Tata 2518, 2523 Hywa
 (3 Straight Holes)
 (139 mm OD)

List Price : Rs.1,940



RDS CP 612

V Stay Centre Bush Tata Signa / Eicher PRO
 (3 Triangular Holes)
 (139 mm OD)

List Price : Rs.1,940

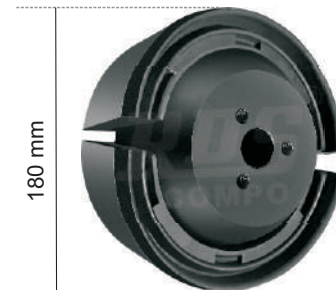

RDS CP 613

V Stay Centre Bush Tata Prima 4923
 (Set of 3 pcs)
 (180 mm OD)

List Price : Rs.5,100



RDS TRB 613

Torque Rod Bush Mahindra Navistar / Torro / Blazo
(90 mm OD) (With Circlips) (Hole Dia 21 mm Round)
(Hole to Hole Distance 130 mm) (Total Length 162 mm)

List Price : Rs.1,725



RDS TRB 614

Torque Rod Bush Eicher Pro (with Short Rod)
(95 mm OD) (With Circlips) (Hole Dia 28 mm Round)
(Hole to Hole Distance 133 mm) (Total Length 178 mm)

List Price : Rs.2,120

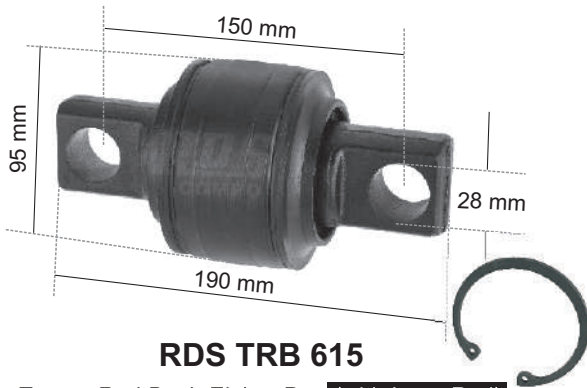

RDS TRB 615

Torque Rod Bush Eicher Pro (with Long Rod)
(95 mm OD) (With Circlips) (Hole Dia 28 mm Round)
(Hole to Hole Distance 150.5 mm) (Total Length 190 mm)

List Price : Rs.2,120



RDS TRB 616

V Rod Bush Eicher Pro
(100 mm OD) (With Circlips) (Double Hole Type)
(Hole Dia 25 mm Round) (Total Length 303 mm)

List Price : Rs.2,808

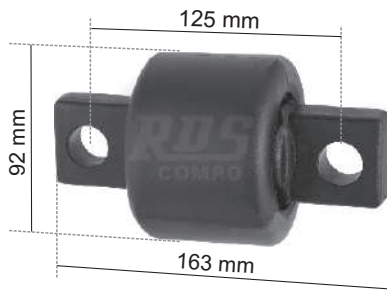

RDS TRB 617

Torque Rod Bush Leyland
(with Cut Mark) (OD 92mm)
(Hole to Hole Distance 125 mm) (Total Length 163 mm)

List Price : Rs.2,260

*Many more
to
come*



RDS 276

Lift Axle Bush Tata 3118 (25 mm ID)
(With Fixed Moulded Pin & 2 Washers)

List Price : Rs.895



RDS 276 A

Lift Axle Bush Tata 3118 (27 mm ID)
(With Fixed Moulded Pin & 2 Washers)

List Price : Rs.895



RDS 277

Lift Axle Bush Tata 3118 (30 mm ID)
(With Fixed Moulded Pin & 2 Washers)

List Price : Rs.895



RDS 280

Lift Axle Bush Leyland BS IV (24 mm ID)
(With Fixed Moulded Pin & 2 Washers)

List Price : Rs.910

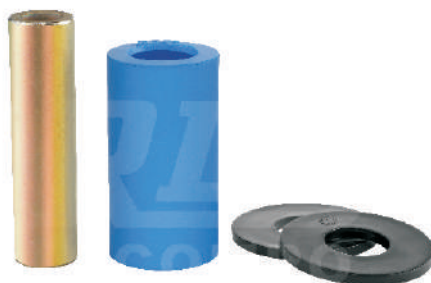

RDS 278

Lift Axle Bush Leyland (PU)
(With Pin & 2 Washers)

List Price : Rs.820



RDS 278 A

Lift Axle Bush Leyland (PU)
(Without Pin & Washers)

List Price : Rs.620



RDS 279
Rubber Bogie Bush
Bharat Benz (Heavy Duty)
List Price : Rs.1,650



RDS 275
Lift Axle Bush
Tata 3118 (PVC)
List Price : Rs.415



RDS 281
Rubber Cabin Mounting
Tata 4923 (Right) with Bracket
List Price : Rs.3,220



RDS 282
Rubber Cabin Mounting
Tata 4923 (Left) with Bracket
List Price : Rs.3,220



RDS 283
Rubber Cabin Bush
Tata 4923 Signa
List Price : Rs.1,540



RDS 284
Rubber Lift Axle Bush
Bharat Benz
List Price : Rs.780

A Product of:
RAGHUNATH UDYOG
ISO 9001:2008 Certified

75, SSI Industrial Area,
G.T. Karnal Road, Delhi-110033 (India)
Phone : +91 11 47098285
email : mohit.sachdevards@gmail.com
www.propellershaftcomponents.in